



nuova

SIMONELLI®

espresso coffee machines



Appia®
MADE IN ITALY

LIBRETTO ISTRUZIONI

USER HANDBOOK

DICHIARAZIONE DI CONFORMITÀ CE
EC DECLARATION OF CONFORMITY



nuova simonelli
espresso coffee machines

Via M. D'Antegiano, 6 - 62031 Belforte del Chienti (MC)

dichiariamo, sotto la nostra responsabilità, che il prodotto:
declare under our responsibility that the product:

MACCHINE PER CAFFÈ ESPRESSO
MODELLI: Appia - versioni V, Esse.

ESPRESSO COFFEE MACHINES
MODELS: Appia - versions V, Esse.

al quale si riferisce questa dichiarazione, è costruito in conformità alle disposizioni:
to which this declaration relates, following the provisions of the Directives:

EN 60335-2-75:2004 + A1:2005 + A11:2006
in combination with
EN 60335-1:2002 + A1:2004 + A11:2004 + A12:2006 + A2:2006
EN 50366:2003 + A1:2006

ed è conforme alle direttive
following the provisions of the Directives

2006 / 95 / CE Low Voltage
2004 / 108 / CE (EMC)

data: Novembre 2008
November 2008

nuova simonelli s.p.a.
L'Amministratore Delegato
(Ottavi Nando)

Complimenti,

con l'acquisto del modello *Appia*. Lei ha fatto un'ottima scelta.

L'acquisto di una macchina per caffè espresso professionale coinvolge diversi fattori di selezione: il nome dell'azienda produttrice, le specifiche funzioni della macchina, l'affidabilità tecnica, la possibilità di una pronta e adeguata assistenza, il costo. Lei certamente ha valutato tutto questo e poi ha deciso: scelgo il modello *Appia*.

Per noi, ha scelto il meglio e potrà verificarlo, caffè dopo caffè, cappuccino dopo cappuccino.

Vedrà quanto sarà comodo, pratico ed efficiente lavorare con *Appia*.

Se è la prima volta che acquista una macchina **Nuova Simonelli**, benvenuto nell'alta caffetteria; se è già nostro Cliente, siamo molto lusingati della Sua fedeltà.

Grazie della preferenza.

Cordialmente,

Nuova Simonelli S.p.a.



Appia[®]
MADE IN ITALY

CARATTERISTICHE TECNICHE

ITALIANO

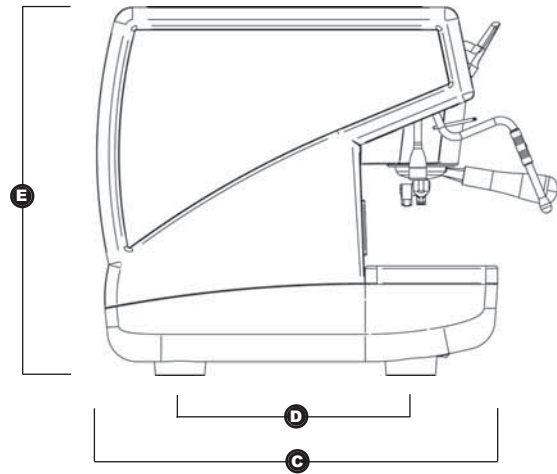
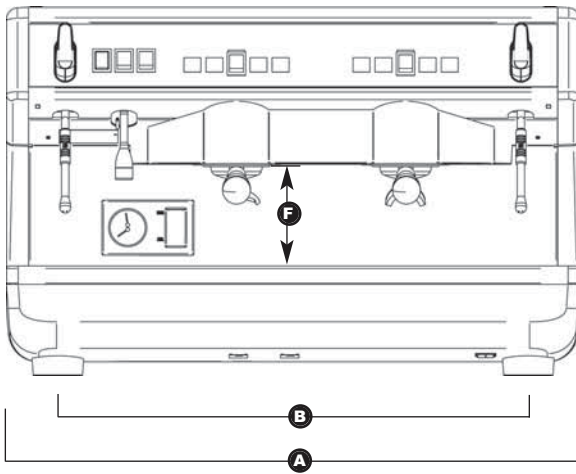

	2 Gruppi		3 Gruppi	
PESO NETTO	60 kg	133 lb	74 kg	163 lb
PESO LORDO	65 kg	143 lb	80 kg	176 lb
POT. TERMICA	3000 W	3000 W	5000 W	5000 W
DIMENSIONI	A 785 mm	A 30 ⁷ / ₈ "	A 1010 mm	A 39 ⁷ / ₈ "
	B 690 mm	B 27 ¹ / ₈ "	B 920 mm	B 36 ³ / ₁₆ "
	C 545 mm	C 21 ⁷ / ₁₆ "	C 545 mm	C 21 ⁷ / ₁₆ "
	D 370 mm	D 14 ⁹ / ₁₆ "	D 370 mm	D 14 ⁹ / ₁₆ "
	E 530 mm	E 20 ¹ / ₁₆ "	E 530 mm	E 20 ¹ / ₁₆ "
	F 135 mm	F 5 ¹ / ₈ "	F 135 mm	F 5 ¹ / ₈ "

Appia[®]
MADE IN ITALY

INDICE

	CARATTERISTICHE TECNICHE	2
1.	DESCRIZIONE	5
1.1	LISTA ACCESSORI	6
2.	PRESCRIZIONI DI SICUREZZA	7
3.	TRASPORTO E MOVIMENTAZIONE	10
3.1	IDENTIFICAZIONE MACCHINA	10
3.2	TRASPORTO	10
3.3	MOVIMENTAZIONE	10
4.	INSTALLAZIONE E OPERAZIONI PRELIMINARI	10
5.	REGOLAZIONI DEL TECNICO QUALIFICATO	12
5.1	RIEMPIMENTO MANUALE CALDAIA	12
5.2	REGOLAZIONE PRESSOSTATO/POMPA	12
5.3	REGOLAZIONE ECONOMIZZATORE ACQUA CALDA (optional versione V/ESSE)	13
5.4	SOSTITUZIONE DELLE PULSANTIERE	13
6.	UTILIZZO	14
6.1	APPIA V	14
6.1.1	ACCENSIONE	14
6.1.2	SPEGNIMENTO	14
6.2	APPIA ESSE	14
6.2.1	ACCENSIONE	14
6.2.2	SPEGNIMENTO	14
6.3	CONFIGURAZIONE SELEZIONE	14
6.4	PREPARAZIONE DEL CAFFE'	15
6.5	UTILIZZO DEL VAPORE	15
6.6	PREPARAZIONE DEL CAPPUCCINO	15
6.7	SELEZIONE ACQUA CALDA	15
7.	PROGRAMMAZIONE APPIA V	16
7.1	PROGRAMMAZIONE DOSI	16
7.2	PROGRAMMAZIONE DOSI CAFFE'	16
7.3	PROGRAMMAZIONE ACQUA CALDA	16
7.4	PROGRAMMAZIONE SCALDATAZZE (optional)	16
7.5	PROGRAMMAZIONE DOSI STANDARD	17
7.6	COPIATURA DOSI	17

7.7	PROGRAMMAZIONE PARAMETRI DI FUNZIONAMENTO	17
7.8	CICLO AUTOMATICO DI PULIZIA GRUPPI	18
8.	PULIZIA E MANUTENZIONE	19
8.1	ARRESTO	19
8.2	PULIZIA DELLA CARROZZERIA	19
8.3	PULIZIA DELLE DOCCETTE INOX	19
8.4	PULIZIA DEL GRUPPO CON L'AUSILIO DEL FILTRO CIECO	19
8.5	PULIZIA DEI FILTRI E PORTAFILTRI	19
8.6	RIGENERAZIONE DELLE RESINE DELL'ADDOLCITORE	20
9.	MESSAGGI FUNZIONI MACCHINA APPIA V	21
	IMPIANTO ELETTRICO APPIA ESSE 2/3 GRUPPI	46
	IMPIANTO ELETTRICO APPIA V 2 GRUPPI	48
	IMPIANTO ELETTRICO APPIA V 3 GRUPPI	50
	IMPIANTO IDRAULICO	52

Appia[®]
MADE IN ITALY

1. DESCRIZIONE *Appia V - Esse*

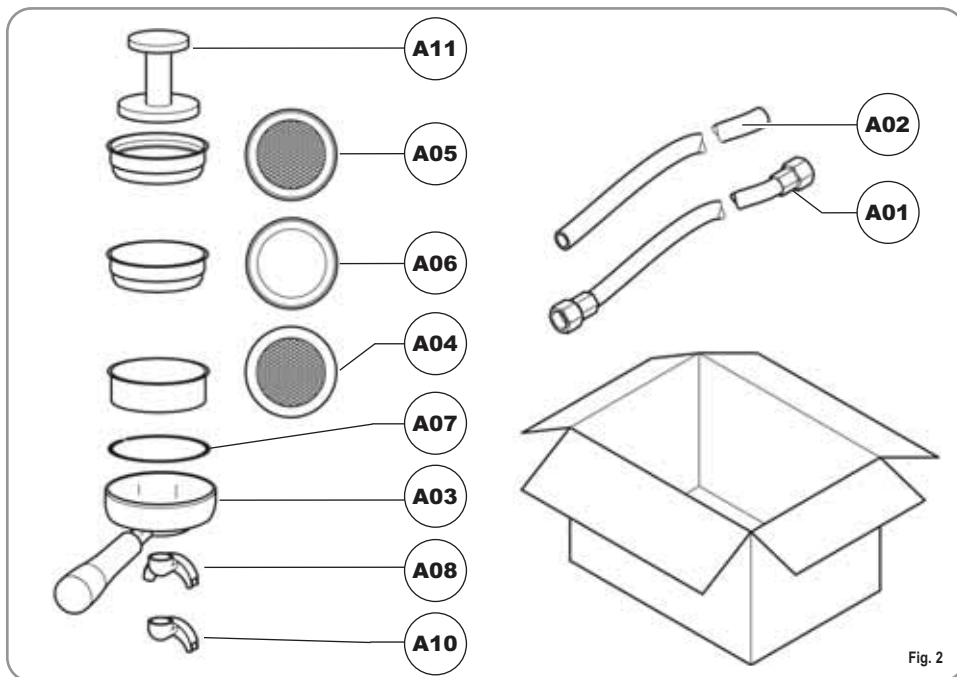

Fig. 1

LEGENDA

- | | |
|-----------------------|---------------------------|
| 1 Pulsanti selezione | 9 Manometro |
| 2 Pulsanti erogazione | 10 Piede regolabile |
| 3 Manopola vapore | 11 Lancia Acqua calda |
| 4 Lancia vapore | 12 Targhetta dati |
| 5 Portafiltro | 13 Interruttore generale |
| 6 Becco 1 caffè | 14 Scaldatazze (optional) |
| 7 Becco 2 caffè | |
| 8 Livello ottico | |

1.1 LISTA ACCESSORI





CODICE	DESCRIZIONE	2 GRUPPI	3 GRUPPI
A01	Tubo carico $\frac{3}{8}$ "	1	1
A02	Tubo scarico Ø 25 mm - L. 150 cm	1	1
A03	Portafiltro	3	4
A04	Filtro doppio	2	3
A05	Filtro singolo	1	1
A06	Filtro cieco	1	1
A07	Molla	3	4
A08	Becco erogazione doppio	2	3
A09	Becco erogazione singolo	1	1
A10	Pressa caffè	1	1

2. PRESCRIZIONI DI SICUREZZA

 Il presente libretto costituisce parte integrante ed essenziale del prodotto e dovrà essere consegnato all'utilizzatore. Leggere attentamente le avvertenze contenute nel presente libretto in quanto forniscono importanti indicazioni riguardanti la sicurezza di installazione, d'uso e manutenzione. Conservare con cura questo libretto per ogni ulteriore consultazione.

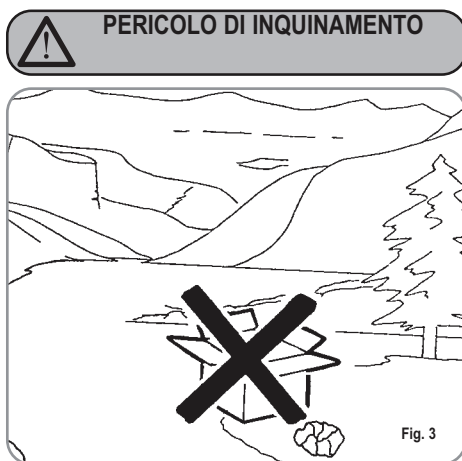
 Dopo aver tolto l'imballaggio assicurarsi dell'integrità dell'apparecchio. In caso di dubbio non utilizzare l'apparecchio e rivolgersi a personale professionalmente qualificato. Gli elementi dell'imballaggio (sacchetti in plastica, polistirolo espanso, chiodi, ecc.) non devono essere lasciati alla portata dei bambini in quanto potenziali fonti di pericolo, né essere dispersi nell'ambiente.



 Prima di collegare l'apparecchio accertarsi che i dati di targa siano rispondenti a quelli della rete di distribuzione elettrica. La targa è situata sul frontale della macchina in alto a destra. L'installazione deve essere effettuata in ottemperanza alle norme vigenti, secondo le istruzioni del costruttore e da personale qualificato.

Il costruttore non può essere considerato responsabile per eventuali danni causati dalla mancanza di messa a terra dell'impianto. Per la sicurezza elettrica di questo apparecchio è obbligatorio predisporre l'impianto di messa a terra, rivolgendosi ad un elettricista munito di patentino, che dovrà verificare che la portata elettrica dell'impianto sia adeguata alla potenza massima dell'apparecchio indicata in targa.



 In particolare dovrà anche accertare che la sezione dei cavi dell'impianto sia idonea alla potenza assorbita dall'apparecchio.

È vietato l'uso di adattatori, prese multiple e prolunghe. Qualora il loro uso si rendesse indispensabile è necessario chiamare un elettricista munito di patentino.

 Per gli apparecchi alimentati a 220-230V, la massima impedenza fornita dalla rete di alimentazione non deve superare gli 0,37 ohm.

 Durante l'installazione del dispositivo devono essere utilizzati i componenti e i materiali in dotazione al dispositivo stesso.

Qualora fosse necessario l'utilizzo di altra componentistica, l'installatore deve verificare l'idoneità dello stesso ad essere utilizzato a contatto con l'acqua per consumo umano.

 L'installatore deve eseguire i collegamenti idraulici rispettando le norme di igiene e sicurezza idraulica di tutela ambientale vigenti nel luogo di installazione. Quindi per l'impianto idraulico rivolgersi ad un tecnico autorizzato.

 L'alimentazione del dispositivo deve essere effettuata con acqua idonea al consumo umano conforme alle disposizioni vigenti nel luogo di installazione. L'installatore deve acquisire dal proprietario/gestore dell'impianto conferma che l'acqua rispetti i requisiti sopra indicati.

 Questo apparecchio dovrà essere destinato solo all'uso descritto in questo manuale. Il costruttore non può essere considerato responsabile per eventuali danni causati da usi impropri, erronei ed irragionevoli.

 L'apparecchio non è idoneo per l'utilizzo da parte dei bambini, persone con ridotte capacità fisiche, sensoriali o mentali, o carenti di conoscenze a meno che non sia data supervisione o istruzione.

 Le temperature massime e minime di immagazzinamento devono essere comprese nel range [-5,+50]°C.

 La temperatura di funzionamento deve essere compresa nel range [+5,+35]°C.

 Al termine dell'installazione, il dispositivo viene attivato e portato fino alla condizione nominale di lavoro lasciandolo in condizioni di "pronto al funzionamento". Successivamente il dispositivo viene spento e tutto il circuito idraulico viene svuotato della prima acqua immessa in modo da eliminare eventuali impurità iniziali.

In seguito il dispositivo viene nuovamente caricato e portato fino alle condizioni nominali di funzionamento. Dopo il raggiungimento dello stato di "pronto al funzionamento" si effettuano le seguenti erogazioni:

- 100% del circuito caffè attraverso l'erogatore caffè (per più erogatori si divida in uguale misura);
- 100% del circuito acqua calda attraverso l'erogatore acqua (per più erogatori si divida in uguale misura);
- apertura di ciascuna uscita vapore per 1 minuto

Al termine dell'installazione sarebbe buona regola stilare un rapporto di quanto effettuato.



ATTENZIONE

Il cavo di alimentazione deve essere sostituito da un Tecnico Specializzato con un Ricambio Originale, disponibile presso i Centri di Assistenza Autorizzati, provvisto di un conduttore di terra speciale.



ATTENZIONE

Nel caso di macchine non dotate di spine di collegamento alla presa elettrica è necessario predisporre la rete con un sezionatore che sezioni ogni fase.



L'uso di un qualsiasi apparecchio elettrico comporta l'osservanza di alcune regole fondamentali.

In particolare:

- non toccare l'apparecchio con mani o piedi bagnati;



ATTENZIONE PERICOLO DI SCOSSA ELETTRICA

- non usare l'apparecchio a piedi nudi;
- non usare, prolunghe in locali adibiti a bagno o doccia;
- non tirare il cavo di alimentazione, per scollegare l'apparecchio dalla rete di alimentazione;
- non lasciare esposto l'apparecchio ad agenti atmosferici (pioggia, sole, ecc.);
- non permettere che l'apparecchio sia usato da bambini, o da personale non autorizzato e che non abbia letto e ben compreso questo manuale.



Il tecnico autorizzato deve, prima di effettuare qualsiasi operazione di manutenzione, spegnere l'interruttore della macchina e staccare la spina o aprire il sezionatore.



Per le operazioni di pulizia attenersi esclusivamente a quanto previsto nel seguente libretto.

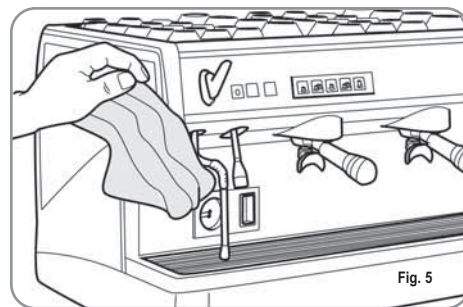

In caso di guasto o di cattivo funzionamento dell'apparecchio, spegnere. È severamente vietato intervenire. Rivolgersi esclusivamente a personale professionalmente qualificato.

L'eventuale riparazione dei prodotti dovrà essere effettuata solamente dalla casa costruttrice o da centro di assistenza autorizzato utilizzando esclusivamente ricambi originali.

Il mancato rispetto di quanto sopra può compromettere la sicurezza dell'apparecchio.



All'installazione, l'elettricista munito di patentino dovrà prevedere un interruttore onnipolare come previsto dalle normative di sicurezza vigenti con distanza di apertura dei contratti uguale o superiore a 3 mm.





Per evitare surriscaldamenti pericolosi si raccomanda di svolgere per tutta la sua lunghezza il cavo di alimentazione.



Non ostruire le griglie di aspirazione e/o di dissipazione in particolare dello scaldatasse.

 Il cavo di alimentazione di questo apparecchio non deve essere sostituito dall'utente. In caso di danneggiamento, spegnere l'apparecchio e per la sua sostituzione rivolgersi esclusivamente a personale professionalmente qualificato.

 Gli apparecchi monofase con corrente superiore a 15A e gli apparecchi trifase venduti senza spina sono collegati all'impianto di alimentazione elettrica direttamente tramite il cavo; non è possibile quindi, l'utilizzo di una spina.

 Allorché si decida di non utilizzare più un apparecchio di questo tipo si raccomanda di renderlo inoperante dopo aver staccato la spina, tagliare il cavo di alimentazione.

 **ATTENZIONE**
PERICOLO DI INQUINAMENTO

 Non disperdere la macchina nell'ambiente: per lo smaltimento rivolgersi ad un centro autorizzato o contattare il costruttore che darà indicazioni in merito.

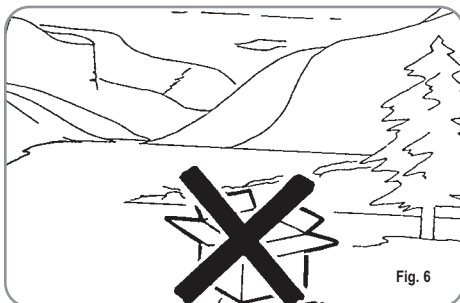

 **ATTENZIONE**
PERICOLO DI INTOSSICAZIONE

 Durante l'uso della lancia del vapore, prestare molta attenzione e non mettere le mani sotto di esso e non toccarla subito dopo l'uso.

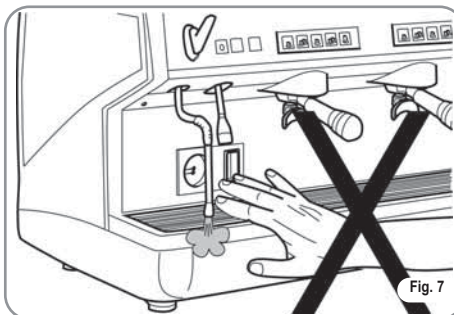

 **ATTENZIONE**
PERICOLO DI USTIONE

 Ricordare che prima di effettuare qualsiasi operazione di installazione, manutenzione, scarico, regolazione, l'operatore qualificato deve indossare i guanti da lavoro e le scarpe antinfortunistiche.

 Il massimo livello di disturbo sonoro emesso è inferiore ai 70db.

 Il tubo alla connessione idrica se sostituito non deve essere più riutilizzato.

 **ATTENZIONE**



INFORMAZIONE AGLI UTENTI
Ai sensi dell' art. 13 del Decreto Legislativo 25 luglio 2005, n. 151 "Attuazione delle Direttive 2002/95/CE, 2002/96/CE e 2003/108/CE, relative alla riduzione dell' uso di sostanze pericolose nelle apparecchiature elettriche ed elettroniche, nonché allo smaltimento dei rifiuti".

Il simbolo del cassonetto barrato riportato sull'apparecchiatura indica che il prodotto alla fine della propria vita utile deve essere raccolto separatamente dagli altri rifiuti. L'utente dovrà, pertanto, conferire l'apparecchiatura giunta a fine vita agli idonei centri di raccolta differenziata dei rifiuti elettronici ed elettrotecnici, oppure riconsegnarla al rivenditore al momento dell'acquisto di una nuova apparecchiatura di tipo equivalente, in ragione di uno a uno. L'adeguata raccolta differenziata per l'avvio successivo dell'apparecchiatura dimessa al riciclaggio, al trattamento e allo smaltimento ambientalmente

compatibile contribuisce ad evitare possibili effetti negativi sull'ambiente e sulla salute e favorisce il riciclo dei materiali di cui è composta l'apparecchiatura. Lo smaltimento abusivo del prodotto da parte dell'utente comporta l'applicazione delle sanzioni amministrative di cui al D.Lgs.n.22/1997" (articolo 50 e seguenti del D.Lgs.n.22/1997).

3. TRASPORTO E MOVIMENTAZIONE

3.1 IDENTIFICAZIONE MACCHINA

Per qualsiasi comunicazione con il costruttore Nuova Simonelli, citare sempre il numero di matricola della macchina.



Fig. 8

3.2 TRASPORTO

La macchina viene trasportata in pallett con più macchine dentro scatoloni assicurati al pallett con delle centine.

Prima di procedere a qualsiasi operazione di trasporto o movimentazione, l'operatore deve:

- indossare guanti e scarpe antinfortunistici ed una tuta con elastici alle estremità.

Il trasporto del pallett deve essere effettuato con un mezzo di sollevamento adeguato (tipo muletto).

3.3 MOVIMENTAZIONE

ATTENZIONE
PERICOLO DI URTO O SCHIACCIAMENTO

L'operatore durante tutta la movimentazione, deve avere l'attenzione che non ci siano persone, cose od oggetti nell'area di operazione.

Sollevare lentamente il pallett a circa 30 cm da terra e raggiungere la zona di carico. Dopo aver verificato che non ci siano ostacoli, cose o persone, procedere al carico.

Una volta arrivati a destinazione, sempre con un mezzo di sollevamento adeguato (es. muletto), dopo essersi assicurati che non ci siano cose o persone nell'area di scarico, portare il pallett a terra e movimentarlo a circa 30 cm da terra, fino all'area di immagazzinamento.

ATTENZIONE
PERICOLO DI URTO O SCHIACCIAMENTO

Prima della seguente operazione verificare che il carico sia a posto e che con il taglio delle centine non cada.

L'operatore con guanti e scarpe antinfortunistiche, deve procedere al taglio delle centine e allo stoccaggio del prodotto, in questa operazione consultare le caratteristiche tecniche del prodotto per vedere il peso della macchina da immagazzinare e potersi regolare di conseguenza.

4. INSTALLAZIONE E OPERAZIONI PRELIMINARI

Una volta rimosso l'imballo e aver verificato l'integrità della macchina e degli accessori, procedere come descritto di seguito:

- posizionare la macchina su un piano orizzontale;
- assemblare i piedini di sostegno della macchina inserendo l'inserto all'interno del guscio cilindrico;
- avvitare il piedino in gomma nella filettatura dell'inserto contenuto nel guscio;
- avvitare tutto il gruppo assemblato nelle apposite sedi di alloggiamento dei piedini della macchina;
- mettere in piano la macchina agendo sui piedini di regolazione;

NOTA: la scanalatura del guscio deve essere rivolta verso l'alto, come indicato nella figura successiva.

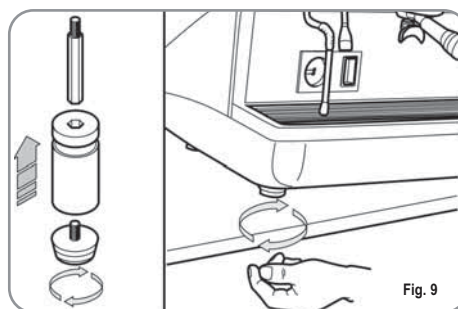
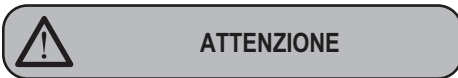

Fig. 9

In fase preliminare, dopo la messa in piano della macchina, si consiglia di installare un addolcitore (1), all'uscita della rete idrica, e di seguito un filtro a maglia (2).

Questo non permette alle impurità, come sabbia, particelle di calcare in sospensione, ruggine ecc., di danneggiare le delicate superfici in grafite, garantendo una buona durata della macchina.

Dopo queste operazioni, provvedere ai collegamenti idraulici come illustrato nella seguente figura.



ATTENZIONE

La pressione della rete idrica raccomandata è [2,3] bar.

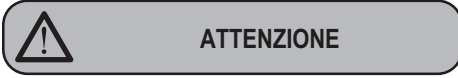

ATTENZIONE

Evitare strozzature nei tubi di collegamento. Verificare inoltre che lo scarico (3) sia in grado di eliminare gli scarti.

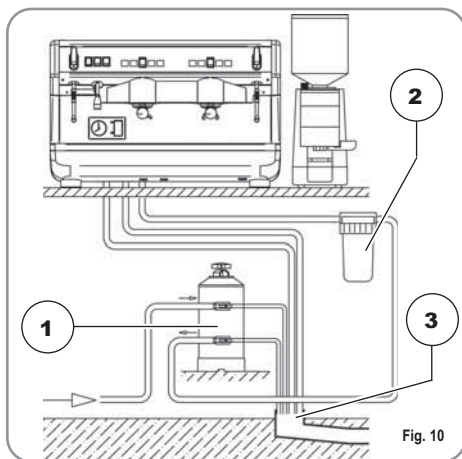
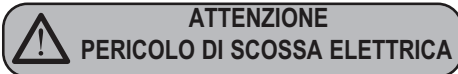

Fig. 10

LEGENDA

- 1 Addolcitore
- 2 Filtro a maglia
- 3 Scarico Ø 50 mm

NOTA: Per un buon funzionamento della macchina occorre che la pressione di rete non superi i 4 bar. In caso contrario, installare un riduttore di pressione a monte dell'addolcitore; il tubo in entrata dell'acqua deve avere un diametro interno non inferiore ai 6 mm (3/8").



PERICOLO DI SCOSSA ELETTRICA

La macchina deve essere sempre protetta

con un interruttore automatico onnipolare di adeguata potenza con distanza di apertura dei contatti uguale o superiore a 3 mm. La Nuova Simonelli non risponde di alcun danno a cose o persone derivante dalla mancata osservanza delle vigenti norme di sicurezza.

Prima di allacciare la macchina a una rete elettrica verificare che il voltaggio indicato sulla targhetta dati della macchina corrisponda a quello della rete.

In caso contrario, effettuare i successivi collegamenti sulla base della linea elettrica a disposizione, come illustrato successivamente:

- per voltaggio **V 380 / 3 fasi +Neutro:**

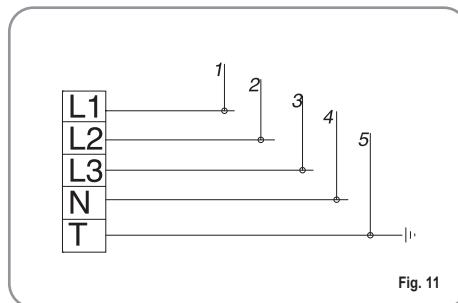

Fig. 11

- per voltaggio **V 230 / monofase**

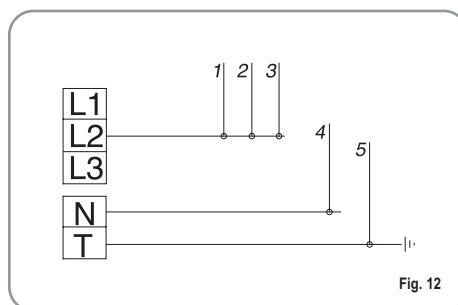

Fig. 12

LEGENDA

- | | |
|-----------|---------------|
| 1 Nero | 4 Blu |
| 2 Grigio | 5 Gialloverde |
| 3 Marrone | |

NOTA: All'inizio della attività giornaliera e comunque nel caso in cui vi siano pause maggiori di 8 ore bisogna procedere ad effettuare il ricambio del 100% dell'acqua contenuta nei circuiti utilizzando gli erogatori preposti.

NOTA: In caso di esercizi in cui il servizio è continuativo effettuare i ricambi di sopra descritti almeno con frequenza settimanale.

5. REGOLAZIONI DEL TECNICO QUALIFICATO



ATTENZIONE

Le regolazioni di seguito elencate devono essere eseguite **SOLO** dal Tecnico Specializzato.

La Nuova Simonelli non risponde di alcun danno a cose o persone, derivanti da una mancata osservanza delle prescrizioni di sicurezza, descritte in questo manuale.



ATTENZIONE PERICOLO DI SCOSSA ELETTRICA

Il tecnico specializzato deve, prima di effettuare qualsiasi operazione di regolazione, spegnere l'interruttore della macchina e staccare la spina.

5.1 RIEMPIMENTO MANUALE CALDAIA

Tutti i modelli *Appia* sono muniti di sonda di livello, per mantenere costante il livello di acqua all'interno della caldaia.

E' buona norma, al primo avviamento della macchina, riempire manualmente la caldaia per evitare che la resistenza elettrica si danneggi e che inserisca la protezione elettronica.

Se questo dovesse accadere, è sufficiente spegnere la macchina e riaccenderla, per completarne il caricamento (vedi capitolo "MESSAGGI FUNZIONE MACCHINA - ERRORE LIVELLO").

Per effettuare il primo riempimento manuale, agire come descritto di seguito:

- rimuovere la griglia del piano di lavoro;

- agire sul rubinetto livello manuale "A", per permettere l'ingrasso dell'acqua nella caldaia;
- raggiunto il livello minimo, indicato dal livello ottico, chiudere il rubinetto "A";

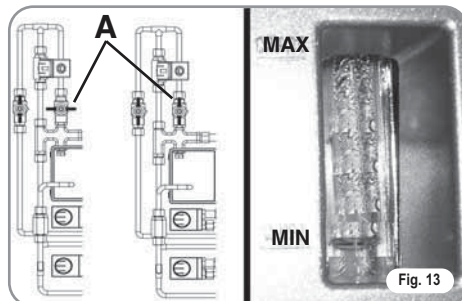

- accendere la macchina, posizionando l'interruttore generale su "I", in modo da attivare la sonda livello, che provvederà al mantenimento in modo automatico dell'acqua nella caldaia.

5.2 REGOLAZIONE PRESSOSTATO / POMPA

Per modificare la pressione di esercizio della caldaia, quindi la temperatura dell'acqua, in funzione delle varie esigenze o delle caratteristiche del caffè utilizzato, agire come descritto di seguito:

- rimuovere la griglia del piano di lavoro;
- togliere la protezione in lamiera svitando le due viti laterali (A) come illustrato nella seguente figura;



- agire sulla vite di regolazione del pressostato per **AUMENTARE** (senso orario) oppure **DIMINUIRE** (senso antiorario) la pressione;

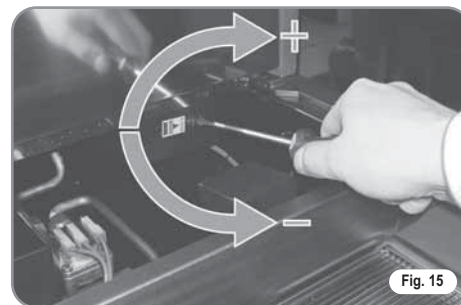

Valore consigliato: 1 - 1,4 bar
(secondo il tipo di caffè).

- Agire sulla vite di regolazione della pompa per **AUMENTARE** (senso orario) oppure **DIMINUIRE** (senso antiorario) la pressione;

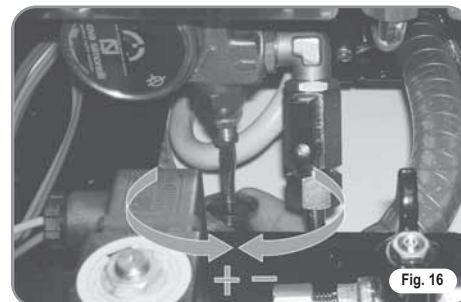

Valore consigliato: 9 bar.

- La pressione impostata della pompa viene visualizzata nel settore inferiore del manometro.

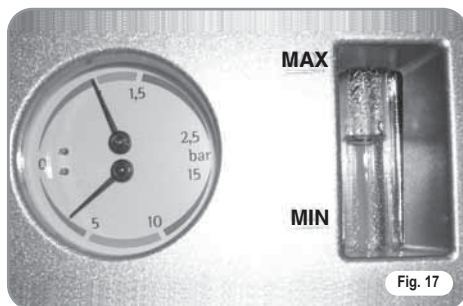

Al termine delle regolazioni, riposizionare la protezione in lamiera nell'apposito alloggiamento e fissarla con le quattro viti laterali; riposizionare la griglia del piano di lavoro.

5.3 **REGOLAZIONE ECONOMIZZATORE ACQUA CALDA (optional versione VESSE)**

Tutti i modelli *Appia* sono equipaggiati di un miscelatore di acqua calda, il quale permette di regolare la temperatura di uscita dell'acqua e di ottimizzare il rendimento del sistema.

Per regolare l'economizzatore acqua calda, occorre rimuovere il pannello sinistro della macchina, operando come descritto di seguito:

- svitare le due viti superiori (Fig. 18);



- svitare la vite di fianco alla lancia vapore A;
- premere il pomello B e rimuovere il pannello sinistro.

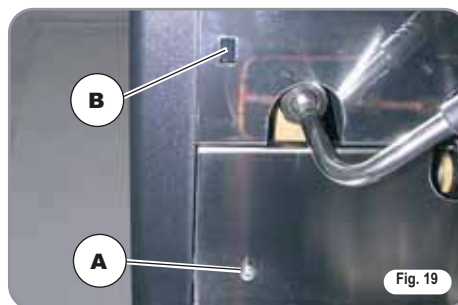

- per regolare la temperatura dell'acqua calda in uscita dalla lancia, ruotare il pomello di registro in senso ORARIO / ANTIORARIO per AUMENTARE / DIMINUIRE la temperatura;

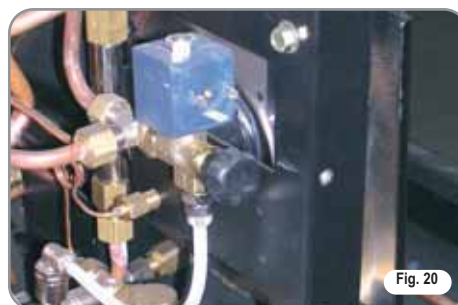

- al termine dell'operazione rimontare il pannello sinistro della macchina.

5.4 **SOSTITUZIONE DELLE PULSANTIERE**

Per un corretto funzionamento occorre, all'atto della sostituzione, personalizzare ogni scheda pulsantiera, agendo sui selettori posti sulla scheda (lato tasti), così come sotto indicato.

GRUPPO	sw1	sw2	sw3	sw4	sw5	sw6
Gruppo 1	On	Off	Off	On	Off	Off
Gruppo 2	Off	On	Off	Off	On	Off
Gruppo 3	Off	Off	On	Off	Off	On

6. UTILIZZO

L'operatore deve prima di iniziare la lavorazione, accertarsi di aver letto e ben compreso le prescrizioni di sicurezza di questo manuale.

6.1 APPIA V

6.1.1 ACCENSIONE

- Collegare la macchina alla presa elettrica.
- Posizionare l'interruttore generale (n.13, Fig 1) in posizione "ON".

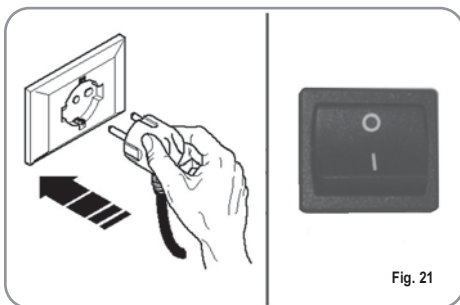





Fig. 21

Il led del tasto accensione  inizierà a lampeggiare.

Mantenere premuto il tasto accensione  per 5 secondi;

a questo punto inizierà il Lamp-test in cui tutti i led sono accesi; dopo 3 secondi il Lamp-test termina e si spegne il tasto acqua calda .

Lo stato di macchina in funzione viene indicato dall'accensione permanente del led tasto accensione  e di tutti i led dei tasti erogazione.

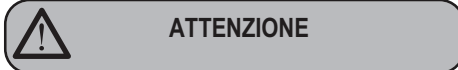

NOTA: tutti i tasti selezione sono abilitati si dalla fine della diagnosi.



ATTENZIONE

In caso di manutenzione alla scheda elettronica, spegnere la macchina tramite l'interruttore generale esterno o scollegare il cavo di alimentazione.

6.1.2 SPEGNIMENTO

- Premendo il tasto accensione/spegnimento  e mantenendolo premuto per circa 2 secondi la macchina si spegne e il led del tasto accensione/spegnimento  torna a lampeggiare.
- Posizionare poi l'interruttore generale in posizione "OFF".

6.2 APPIA ESSE

6.2.1 ACCENSIONE

- Collegare la macchina alla presa elettrica e posizionare l'interruttore generale in posizione "I".

6.2.2 SPEGNIMENTO

- Posizionare l'interruttore generale in posizione "O".

6.3 CONFIGURAZIONE SELEZIONE

Impostare la funzione desiderata sui tasti a disposizione posti sopra i portafiltri (Vedi capitolo "DESCRIZIONE").



Fig. 22

LEGENDA TASTI (Configurazione selezioni)



1 Caffè corto



2 Caffè corto



1 Caffè lungo



2 Caffè lungo



Continuo

6.4 PREPARAZIONE DEL CAFFÈ

Sganciare il portafiltro e riempire di una o due dosi di caffè macinato a seconda del filtro utilizzato.

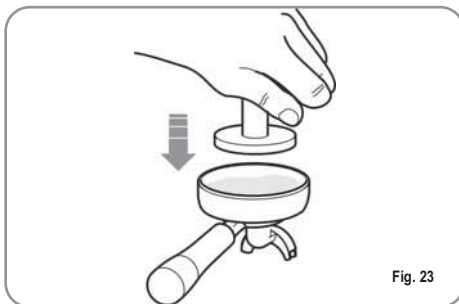

Fig. 23

Pressare il caffè con l'apposito pressino in dotazione, pulire dai residui di polvere di caffè il bordo anulare del filtro (per garantire una migliore tenuta e un'inferiore usura della guarnizione).

Innestare quindi il portafiltro nel gruppo. Premere il pulsante caffè desiderato:



1 Caffè corto



2 Caffè corto



1 Caffè lungo



2 Caffè lungo

Si attiva la pompa e si apre l'elettrovalvola del gruppo dando avvio all'infusione del caffè. L'operazione è evidenziata dall'accensione del tasto premuto.

NOTA: nelle fasi di pausa, lasciare il portafiltro innestato al gruppo affinché rimanga sempre caldo.

I gruppi di erogazione sono termocom-

pensati a circolazione totale di acqua calda, per garantire la massima stabilità termica durante l'esercizio.

6.5 UTILIZZO DEL VAPORE



**ATTENZIONE
PERICOLO DI USTIONE**

Durante l'uso della lancia del vapore, prestare molta attenzione a non mettere le mani sotto di essa e non toccarla subito dopo.

Per utilizzare il vapore è sufficiente tirare o spingere l'apposita leva (Fig. 24).

Tirando completamente, la leva rimane bloccata nella posizione di massima erogazione, spingendo, il ritorno della leva è automatico.

Le due lance vapore sono snodate, consentendo un più agevole utilizzo delle stesse.



Fig. 24

NOTA: L'utilizzo della lancia vapore deve essere sempre preceduta dall'operazione di spurgo della condensa per almeno 2 secondi o seguendo le istruzioni del costruttore.

6.6 PREPARAZIONE DEL CAPPUCCINO

Per ottenere la tipica schiuma immergere il beccuccio del vapore in fondo al recipiente

pieno per 1/3 (preferibilmente a forma tronco-conica). Aprire il vapore. Prima che il latte abbia raggiunto lo stato di ebollizione, spostare il beccuccio del vapore in superficie facendo sfiorare il latte con piccoli spostamenti in senso verticale. Alla fine dell'operazione pulire accuratamente la lancia con un panno morbido.

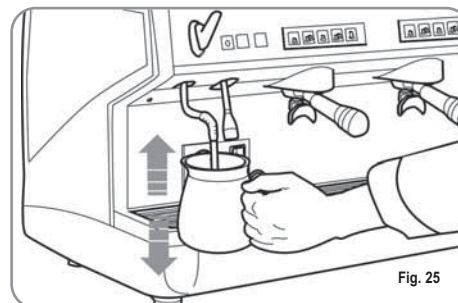

Fig. 25

6.7 SELEZIONE ACQUA CALDA



**ATTENZIONE
PERICOLO DI USTIONE**

Durante l'uso della lancia dell'acqua calda, prestare molta attenzione a non mettere le mani sotto di essa e non toccarla subito dopo.

Consente l'erogazione di acqua calda per preparare tè, camomilla e tisane.

Posizionare sotto la lancia acqua calda un contenitore e azionare interruttore (versione ESSE) o premere il pulsante selezione acqua calda  (versione V).

Assicurarsi che il pulsante stesso si illumini. Dalla lancia acqua calda verrà erogata acqua per un tempo equivalente al valore programmato.

NOTA: L'erogazione dell'acqua calda può avvenire contemporaneamente a quella del caffè.

7. PROGRAMMAZIONE Appia V

7.1 PROGRAMMAZIONE DOSI

Per entrare negli ambienti di programmazione, operare come descritto:

NOTA: Operazione eseguibile a macchina accesa.

- Per entrare nello stato di programmazione dosi di ogni gruppo è necessario premere per 5 sec. il tasto erogazione continua



- I tasti erogazione cominceranno a lampeggiare.
- L'accesso alla programmazione del primo gruppo abilita anche l'impostazione dei parametri di funzionamento della macchina.

7.2 PROGRAMMAZIONE DOSI CAFFÈ'

Per programmare la dose di acqua relativa a uno dei tasti erogazione, procedere come segue:

- riempire con la giusta dose di caffè il portafiltro (il portafiltro può essere singolo o doppio, a seconda del tasto che si desidera programmare).
- Immettere il portafiltro nel gruppo.
- Premere uno dei pulsanti erogatori:



- L'erogazione ha inizio; una volta raggiunta la quantità desiderata premere il tasto continuo



- L'erogazione si arresta e il tasto dose scelto si spegne (gli altri tasti continuano a lampeggiare).



- Premere il tasto continuo per uscire dalla programmazione o continuare la programmazione di altri tasti dose.

NOTA: Questa procedura è utilizzabile per tutti i gruppi della macchina ad eccezione che venga effettuata un gruppo alla volta, gli altri gruppi possono continuare a operare normalmente.

7.3 PROGRAMMAZIONE ACQUA CALDA

- Entrare in programmazione secondo la relativa procedura.
- Premere il tasto selezione acqua calda



- L'erogazione dell'acqua calda ha inizio.
- Stabilire la dose di acqua calda desiderata e premere nuovamente il tasto



- Premere il tasto continuo per uscire dalla programmazione o continuare la programmazione di altri tasti selezione.



7.4 PROGRAMMAZIONE SCALDATAZZE (optional)

- Entrare in programmazione del primo gruppo secondo la relativa procedura.
- Premere il tasto selezione scaldatazze



- I pulsanti erogazione del primo e del secondo gruppo segnalano rispettivamente il tempo di accensione e di spegnimento in modalità automatica mentre lampeggiano i tasti continuo del primo e del secondo gruppo.



Come descritto in tabella, ad ognuno dei tasti erogazione è associato un valore; il tempo di accensione dello scaldatazze è dato dalla somma dei valori dei tasti del primo gruppo illuminati. La stessa modalità di conteggio avviene per il tempo di spegnimento dello scaldatazze con i tasti del secondo gruppo.

Tasto	Gruppo 1 (tempo on)	Gruppo 2 (tempo off)
	2 min.	5 min.
	4 min.	10 min.
	8 min.	20 min.
	16 min.	40 min.

7.5 PROGRAMMAZIONE DOSI STANDARD

E' possibile impostare dei valori predeterminati per le 4 dosi del gruppo, per l'acqua (vapore).



Per fare ciò occorre premere il tasto e mantenerlo premuto per almeno 10 secondi fino a quando i tasti lampeggianti si spengono.

Le dosi sono:

1CN	2CN	1CL	2CL
40 cc	60 cc	50 cc	85 cc

ACQUA
9 sec.

NOTA: Un tempo di 0 secondi per l'acqua e per il vapore ne determina il funzionamento in continuo.

7.6 COPIATURA DOSI

E' possibile copiare le dosi memorizzate per il gruppo 1 nelle dosi del gruppo 2 o 3.

Questa operazione, avviene premendo il tasto continuo



del gruppo 2 o 3 almeno per 8 secondi fino a quando i tasti lampeggianti si spengono.

7.7 PROGRAMMAZIONE PARAMETRI DI FUNZIONAMENTO



Le regolazioni di seguito elencate devono essere eseguite **SOLO** dal Tecnico Specializzato.



Premendo il tasto del secondo gruppo, dopo essere entrati in programmazione del primo gruppo, si accede all'impostazione dei parametri di funzionamento macchina; situazione segnalata dall'accensione del tasto continuo del secondo gruppo



1. Attivazione pompa se attivato livello.
2. Attivazione blocco software per ingresso in programmazione dosi.
3. Regolazione luminosità tastiera.
4. Attivazione pompa con acqua calda (nelle macchine con economizzatore).
5. Disabilitazione scaldatazze.
6. Ripristino parametri di default.

1. Attivazione pompa durante livello.



Tramite il tasto caffè corto del secondo gruppo si imposta l'attivazione della pompa durante il livello:



se il tasto è acceso la pompa si attiva assieme al livello, se è spento la pompa non si attiva con il livello.

2. Attivazione blocco software per l'ingresso in programmazione dosi.



Tramite il tasto caffè lungo si attiva il blocco software per la programmazione delle dosi (tasto acceso) o si disattiva il blocco (tasto spento).

3. Regolazione luminosità tastiera.



Il tasto 2 caffè lunghi del secondo gruppo viene utilizzato per scegliere la luminosità dei tasti tra 5 livelli preimpostati.



Premendo il tasto, che lampeggia, si cambia il livello, abbassando il valore fino al minimo per poi ritornare al valore massimo.

4. Attivazione pompa con acqua calda (solo per macchine con economizzatore).



Tramite il tasto acqua calda si imposta l'attivazione della pompa durante l'erogazione di acqua.



Se il tasto è acceso la pompa si attiva durante l'erogazione di acqua calda, se è spento la pompa non si attiva.

5. Disabilitazione scaldatazze.



Tramite il tasto si attiva o si disattiva il funzionamento dello scaldatazze; se il tasto è acceso, lo scaldatazze funziona normalmente come impostato nella programmazione, se il tasto è spento lo scaldatazze è disabilitato.

Se lo scaldatasse non è abilitato, il tasto  si accende solamente durante il Lamp-

test, dopodichè ogni pressione del tasto non ha alcun effetto.

Premendo il tasto continuo  del secondo gruppo vengono memorizzati i valori modificati e si esce dalla pagina per l'impostazioni parametri funzionamento macchina.



6. Ripristino parametri di default



E' possibile un ripristino dei parametri di default, cioè livello pompa, acqua con pompa, luce massima e scaldatasse abilitato.

Per ripristinare questi parametri è sufficiente accendere la macchina, tramite il tasto ,

con i tasti 2 caffè corti  e 2 caffè lunghi  del primo gruppo premuti contemporaneamente.

7.8 CICLO AUTOMATICO DI PULIZIA GRUPPI



Per entrare nello stato di pulizia automatica si deve spegnere la macchina e riaccenderla mantenendo premuti i tasti acqua calda  e scaldatasse  durante il Lamp-test iniziale.



Al termine del Lamp-test iniziano a lampeggiare i tasti  e  ed i tasti un caffè lungo

 di tutti i gruppi.



Premendo il tasto  inizia il ciclo di lavaggio del relativo gruppo.

Terminato il ciclo di lavaggio si può effettuare il ciclo di risciacquo sullo stesso gruppo, premendo nuovamente il tasto .

Se si vuole eseguire il ciclo di risciacquo in un secondo momento è sufficiente spegnere la macchina: la scheda mantiene memorizzati i cicli di pulizia da terminare. Alla successiva accensione, infatti, la scheda entrerà automaticamente nello stato di pulizia gruppi, senza premere i tasti  e .

Premendo i tasti  e  per 2 secondi si esce dallo stato di pulizia nel caso in cui non ci siano cicli da terminare, altrimenti rimarranno lampeggianti i tasti  dei gruppi in cui

si deve ancora eseguire il ciclo di risciacquo.

Mantenendo i tasti  e  per altri 2 secondi, si forza l'uscita dallo stato di pulizia azzerando l'informazione sui risciacqui da terminare.

Se il ciclo di pulizia viene completato, il tasto  del gruppo si spegne.

Se non ci sono altri risciacqui da seguire la scheda esce dallo stato di pulizia.

8. PULIZIA E MANUTENZIONE

Durante la manutenzione/riparazione i componenti utilizzati devono garantire di mantenere i requisiti di igiene e sicurezza previsti per il dispositivo. I ricambi originali forniscono questa garanzia.

Dopo una riparazione o una sostituzione di componenti che riguardano parti a contatto con acqua e alimenti, deve essere effettuata la procedura di lavaggio o seguendo le procedure indicate dal costruttore.

8.1 ARRESTO

Per arrestare la macchina bisogna ripremere l'interruttore generale e portarlo nella posizione OFF.



Fig. 26

8.2 PULIZIA DELLA CARROZZERIA

Prima di effettuare qualsiasi operazione di pulizia, bisogna portare la macchina a stato energetico "OFF" (cioè interruttore macchina spento e spina staccata o sezionatore aperto).



ATTENZIONE

Non utilizzare solventi, prodotti a base di cloro, abrasivi.



ATTENZIONE

Non è possibile pulire l'apparecchio con getto d'acqua o immergendolo in acqua.

Pulizia zona lavoro: togliere la griglia del pianolavoro sollevandolo anteriormente verso l'alto e sfilarlo, togliere il sottostante piatto raccogliacqua e pulire il tutto con acqua calda e detersivo. **Pulizia carena:** per pulire tutte le parti cromate utilizzare un panno morbido inumidito.

8.3 PULIZIA DELLE DOCCETTE INOX

Le doccette inox sono situate sotto i gruppi erogazione, come si vede in figura.



Fig. 27

NOTA: Per la pulizia operare come descritto:

- Svitare la vite posta al centro della doccetta.
- Sfilare la doccetta e verificare che i fori non siano ostruiti.
- In caso di ostruzioni pulire secondo descrizione (Paragrafo "PULIZIA DEI FILTRI E PORTAFILTRI).

Si raccomanda di effettuare la pulizia delle doccette settimanalmente.

8.4 PULIZIA DEL GRUPPO CON L'AUSILIO DEL FILTRO CIECO

La macchina è predisposta per il lavaggio del gruppo erogazione tramite detergente specifico in polvere.

E' consigliabile effettuare il lavaggio almeno una volta al giorno con gli appositi detersivi.



ATTENZIONE
PERICOLO DI INTOSSICAZIONE

Una volta tolto il portafiltro effettuare alcune erogazioni per eliminare eventuali residui di detergente.

Per eseguire la procedura di lavaggio procedere come segue:

- 1) Sostituire il filtro con quello cieco del gruppo erogatore.
- 2) Mettervi all'interno due cucchiaini di detergente specifico in polvere e immettere il portafiltro al gruppo.
- 3) Premere uno dei tasti caffè e arrestare dopo 10 sec. .
- 4) Ripetere l'operazione più volte.
- 5) Togliere i portafiltro ed effettuare alcune erogazioni.

8.5 PULIZIA DEI FILTRI E PORTAFILTRI

Mettere due cucchiaini di detergente specifico in mezzo litro d'acqua calda e immettere filtro e portafiltro (escluso il manico) per almeno mezz'ora. Dopodichè risciacquare in abbondante acqua corrente.

8.6 RIGENERAZIONE DELLE RESINE DELL'ADDOLCITORE

Al fine di evitare la formazione di depositi calcarei all'interno della caldaia e degli scambiatori di calore è necessario che l'addolcitore sia sempre in perfetta efficienza. Occorre perciò effettuare regolarmente la rigenerazione delle resine ioniche.

I tempi di rigenerazione vanno stabiliti in funzione della quantità di caffè erogati giornalmente e della durezza dell'acqua utilizzata. Indicativamente si possono rilevare dal diagramma riportato in Fig. 28.

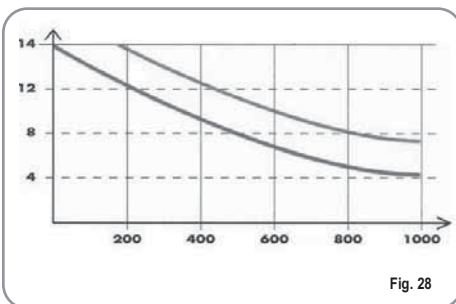

Le procedure di rigenerazione sono le seguenti:

1) Spegnerne la macchina e mettere un recipiente della capacità di almeno 5 litri sotto il tubo E (Fig. 29).

Ruotare le leve C e D da sinistra verso destra; togliere il tappo svitando la manopola G e introdurre 1 Kg di sale grosso da cucina (Fig. 30).

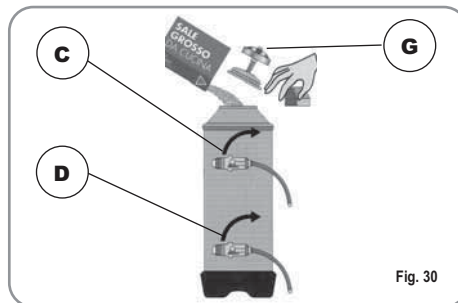
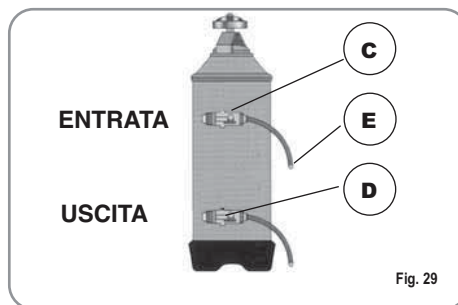

2) Rimettere il tappo e riposizionare la leva C verso sinistra (Fig. 31), lasciando scaricare l'acqua salata dal tubo F finché non ritorni dolce (circa 1/2 ora).

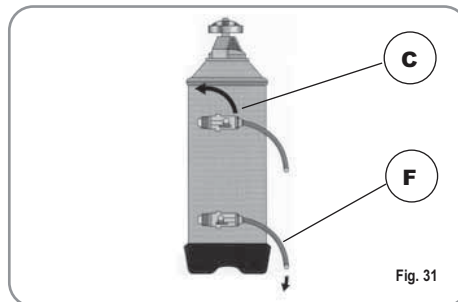

3) Riportare quindi la leva D verso sinistra (Fig. 32).

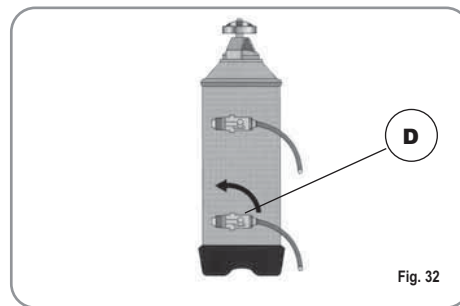

9. MESSAGGI FUNZIONI MACCHINA Appia V

INDICAZIONI DISPLAY E TASTI	CAUSA	EFFETTO	SOLUZIONE	NOTA
<p>Disegno tasto continuo lampeggiante  lam-</p> <p>e tasto erogazione  fisso.</p>	<p>Se entro i primi tre sec. dall'inizio dell'erogazione il dosatore non invia impulsi.</p>	<p>Se l'erogazione non è interrotta manualmente si arriva al blocco di tempo limite (120 sec.).</p>	<p>Interrompere l'erogazione.</p>	
<p>Disegno tasto continuo lampeggiante. </p>	<p>Se dopo 90 sec. dall'inizio, con pompa inserita durante altolivello, a 180 sec. se è disabilitata, il livello non è stata ripristinato.</p>	<p>Viene disattivata la pompa, la resistenza e tutte le funzioni sono inibite.</p>	<p>Spegnere la macchina per almeno 5 sec. e riaccenderla.</p>	

NOTE:

ITALIANO

A series of horizontal dotted lines for taking notes.

Congratulations,

By purchasing the *Appia* you have made an excellent choice.

The purchase of a professional espresso coffee-maker involves various elements of selection: the name of the manufacturing firm, the machine's specific functions, its technical reliability, the option of immediate and suitable servicing, its price. You certainly evaluated all these factors and then made your choice: the *Appia* model.

We think you have made the best choice and after every coffee and cappuccino you will be able to assess this.

You will see how practical, convenient and efficient working with *Appia* is.

If this is the first time you have bought a **Nuova Simonelli** coffee machine, welcome to high quality coffee-making; if you are already a customer of ours, we feel flattered by the trust you have shown us.

Thanks of the preference.

With best wishes,

Nuova Simonelli S.p.a.



Appia[®]
MADE IN ITALY

TECHNICAL CHARACTERISTICS

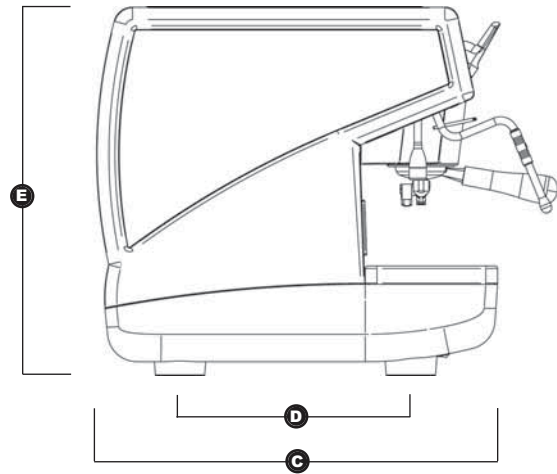
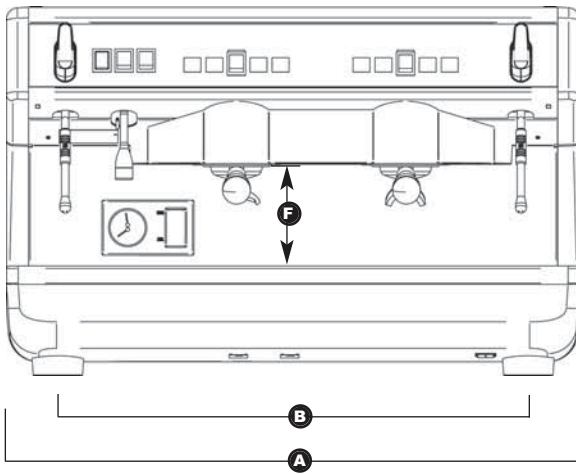

	2 Groups		3 Groups	
NET WEIGHT	60 kg	133 lb	74 kg	163 lb
GROS WEIGHT	65 kg	143 lb	80 kg	176 lb
POWER	3000 W	3000 W	5000 W	5000 W
DIMENSIONS	A 785 mm	A 30 ⁷ / ₈ "	A 1010 mm	A 39 ⁷ / ₈ "
	B 690 mm	B 27 ¹ / ₈ "	B 920 mm	B 36 ³ / ₁₆ "
	C 545 mm	C 21 ⁷ / ₁₆ "	C 545 mm	C 21 ⁷ / ₁₆ "
	D 370 mm	D 14 ⁹ / ₁₆ "	D 370 mm	D 14 ⁹ / ₁₆ "
	E 530 mm	E 20 ¹ / ₁₆ "	E 530 mm	E 20 ¹ / ₁₆ "
	F 135 mm	F 5 ¹ / ₈ "	F 135 mm	F 5 ¹ / ₈ "

INDEX

	TECHNICAL CHARACTERISTICS24
1.	DESCRIPTION27
1.1	ACCESSORIES LIST28
2.	SAFETY PRESCRIPTION29
3.	TRANSPORT AND HANDLING32
3.1	MACHINE IDENTIFICATION32
3.2	TRANSPORT32
3.3	HANDLING32
4.	INSTALLATION AND PRELIMINARY OPERATIONS33
5.	ADJUSTMENTS TO BE MADE BY A QUALIFIED TECHNICIAN ONLY34
5.1	PRESSURE SWITCH ADJUSTMENT34
5.2	PUMP ADJUSTMENT34
5.3	HOT WATER ECONOMISER ADJUSTMENT (optional V/ESSE model)35
5.4	PUSH-BUTTONPANEL REPLACEMENT35
6.	USE36
6.1	APPIA V36
6.1.1	SWITCHING THE MACHINE ON36
6.1.2	SWITCHING THE MACHINE OFF36
6.2	APPIA ESSE36
6.2.1	SWITCHING THE MACHINE ON36
6.2.2	SWITCHING THE MACHINE OFF36
6.3	SELECTION CONFIGURATION36
6.4	MAKING COFFE37
6.5	USING STEAM37
6.6	MAKING CAPPUCCINO37
6.7	HOT WATER SELECTION37
7.	PROGRAMMING APPIA V38
7.1	PROGRAMMING DOSES38
7.2	PROGRAMMING COFFEE DOSES38
7.3	PROGRAMMING HOT WATER38
7.4	PROGRAMMING THE CUP WARMER (optional)38

7.5	PROGRAMMING STANDARD DOSES39
7.6	COPYING DOSE SETTINGS39
7.7	PROGRAMMING OPERATING PARAMETERS39
7.8	AUTOMATIC GROUP CLEANING CYCLE40
8.	CLEANING AND MAINTENANCE41
8.1	STOPPING THE MACHINE41
8.2	CLEANING THE OUTSIDE OF THE MACHINE41
8.3	CLEANING THE STAINLESS COFFEE-HOLDERS41
8.4	CLEANING THE UNIT WITH THE AID OF THE BLIND FILTER41
8.5	CLEANING FILTERS AND FILTER-HOLDERS41
8.6	RESIN AND SOFTENER REGENERATION42
9.	APPIA V MACHINE FUNCTION MESSAGES43
	ELECTRIC SYSTEM APPIA ESSE2/3 GR46
	ELECTRIC SYSTEM APPIA V 2 GR.48
	ELECTRIC SYSTEM APPIA V 3 GR.50
	PLUMBING SYSTEM52

Appia[®]
MADE IN ITALY

1. DESCRIPTION *Appia V - Esse*

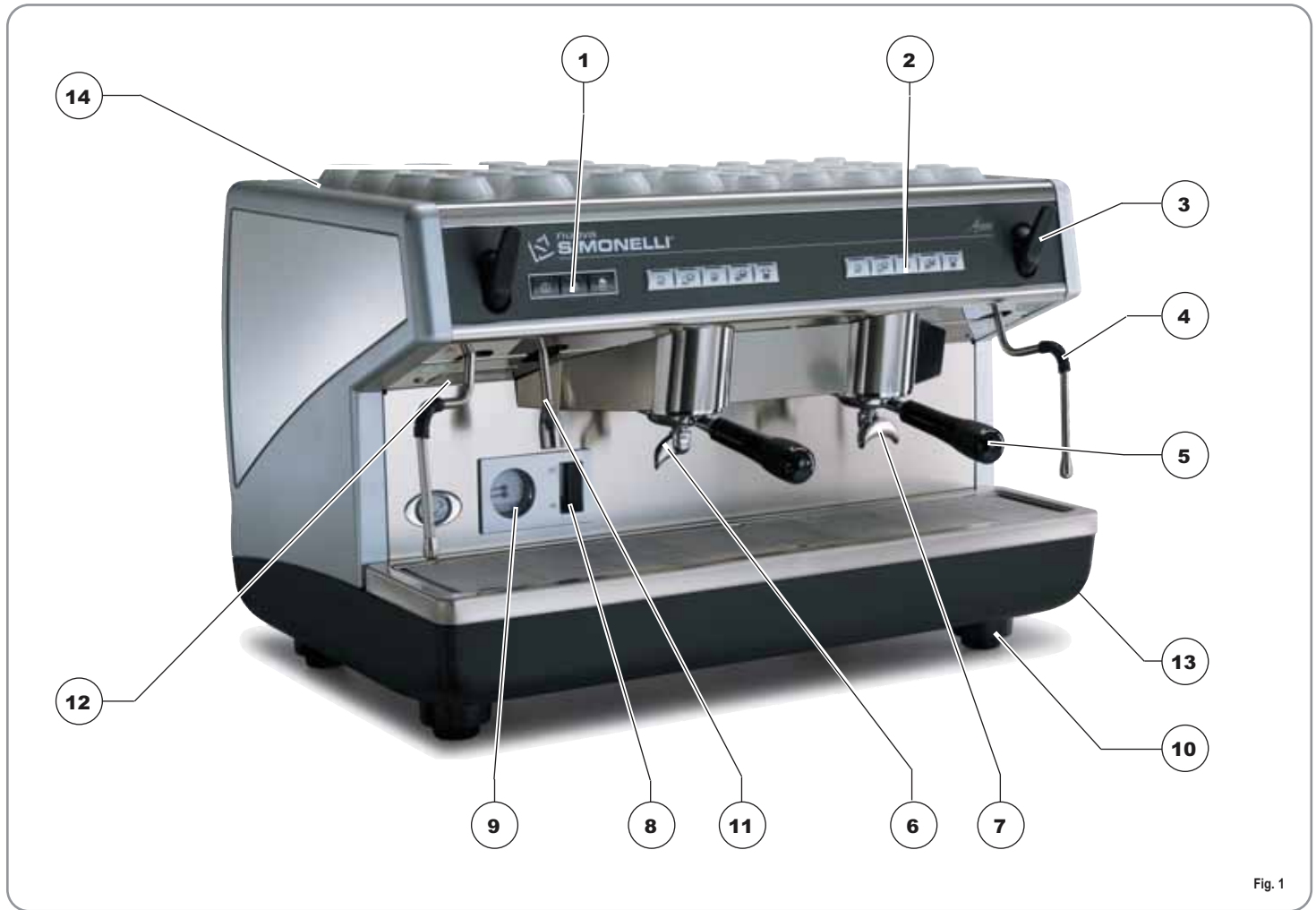
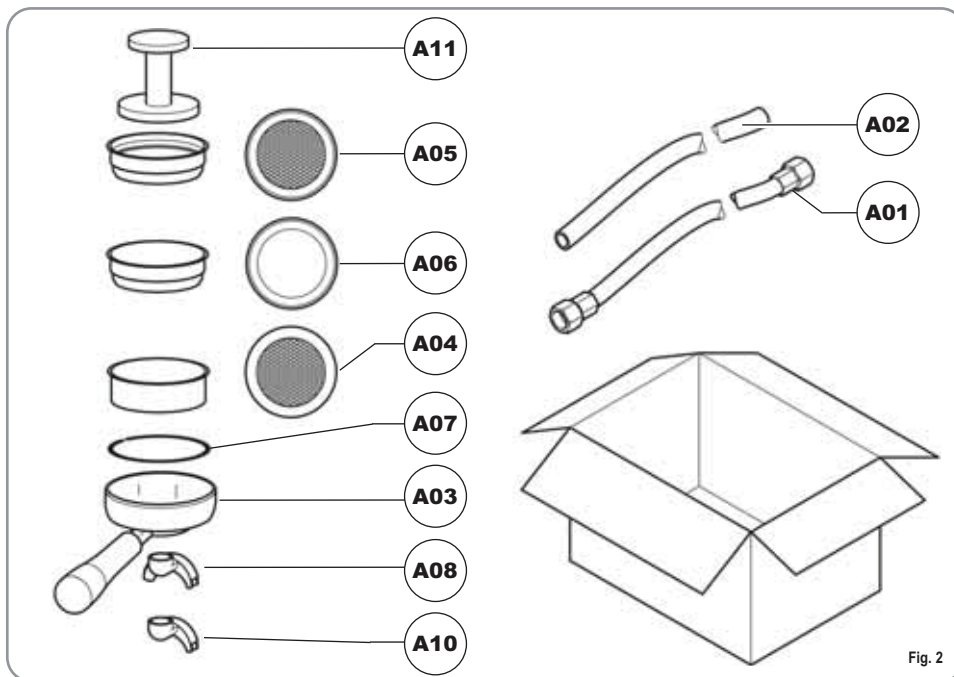

Fig. 1

KEY

- | | | | |
|---|-----------------------|----|-----------------------|
| 1 | Select buttons | 9 | Pressure gauge |
| 2 | Delivery buttons | 10 | Adjustable foot |
| 3 | Steam knob | 11 | Hot water nozzle |
| 4 | Steam nozzle | 12 | Rating plate |
| 5 | Filter holder | 13 | Main switch |
| 6 | Single delivery spout | 14 | Cup warmer (optional) |
| 7 | Double delivery spout | | |
| 8 | Optical level | | |

1.1 ACCESSORIES LIST





CODE	DESCRIPTION	QUANTITY
A01	Filling tube 3/8"	1
A02	Waste pipe Ø 25 mm - L. 150 cm	1
A03	Filter-holder	2
A04	Double filter	1
A05	Single filter	1
A06	Blind filter	1
A07	Spring	1
A08	Double delivery spout	1
A09	Single delivery spout	1
A10	Coffee presser	1

2. SAFETY PRESCRIPTION

 This book is an integral and essential part of the product and must be given to the user. Read this book carefully. It provides important information concerning safety of installation, use and maintenance. Save it carefully for future reference.

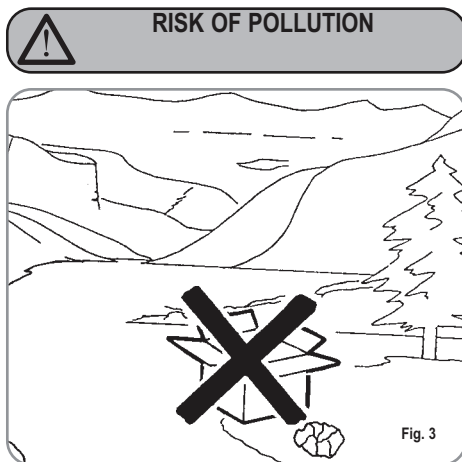
 After unpacking, make sure the appliance is complete. In case of doubts, do not use the appliance, but consult a qualified technician. Packaging items which are potentially dangerous (plastic bags, polystyrene foam, nails, etc.) must be kept out of children's reach and must not be disposed of in the environment.



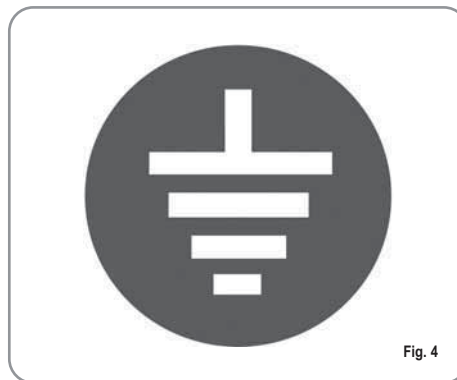

 Before connecting the appliance make sure the rating plate data correspond with the mains. This plate is on the front panel at the top right hand side of the appliance. The appliance must be installed by qualified technicians in accordance with current standards and manufacturer's instructions.

The manufacturer is not liable for any damage caused due to failure to ground the system. For the electrical safety of the appliance, it is necessary to equip the system with the proper grounding. This must be carried out by a qualified electrician who must ensure that the electric power of the system is sufficient to absorb the maximum power input stated on the plate.





 In particular you must ensure that the size of the wiring cables is sufficient to absorb power input. The use of adapters, multiple sockets or extensions is strictly forbidden. If they prove necessary, call a fully qualified electrician.

 For appliances powered at 220 -230 V, the maximum impedance from the mains must be no higher than 0.37 Ohm.

 When installing the device, it is necessary to use the parts and materials supplied with the device itself. Should it be necessary to use other parts, the installation engineer needs to check their suitability for use in contact with water for human consumption.

 The machine must be installed in compliance with the local health standards in force for plumbing systems. Therefore, contact an authorized plumber.

 The device needs to be supplied with water that is suitable for human consumption and compliant with the regulations in force in the place of installation. The installation engineer needs confirmation from the owner/manager of the system that the water complies with the requirements and standards stated above.

 The machine must be installed according to the local standards in force with regard to plumbing systems. For this reason, the plumbing connections must be carried out by a qualified technician.

 This appliance must only be used as described in this handbook. The manufacturer shall not be liable for any damage caused due to improper, incorrect and unreasonable use.

 This appliance is not suitable for use by children or persons with reduced physical, sensory or mental capabilities, or by persons with a lack of experience or knowledge, unless supervised or given instructions.

 The maximum and minimum storage temperatures must fall within a range of [-5, +50]°C.

 The operating temperature must be within the range of [+5, +35]°C.

 At the end of installation, the device is switched on and taken to rated operating conditions, leaving it in a state in which it is “ready for operation”.

The device is then switched off and the whole hydraulic circuit is bled of the first lot of water in order to remove any initial impurities.

The device is then refilled and taken to rated operating conditions.

After reaching the “ready for operation” condition, the following dispensing operations are carried out:

- 100% of the coffee circuit through the coffee dispenser (for more than one dispenser, this is divided equally);
- 100% of the hot water circuit through the water dispenser (for more than one dispenser, this is divided equally);
- opening of each steam outlet for 1 minute.

At the end of installation, it is good practice to draw up a report of the operations.



WARNING

The power cord may only be replaced by a Qualified Electrician, using an Original Replacement fitted with special earth wire, which is available from Authorised Assistance Centres.



WARNING

For machines not equipped with plugs to fit the mains power socket, it is necessary to fit the system with a disconnector to disconnect each phase.



Basic rules must be observed when using any electric appliance.

In particular:

- do not touch the appliance when hands or feet are wet;



CAUTION RISK OF ELECTRIC SHOCK

- do not use the appliance when barefoot;
- do not use extensions in bath or shower rooms;
- do not pull the supply cord out of the socket to disconnect it from the mains;
- do not leave the appliance exposed to atmospheric agents (rain, sun, etc.);
- do not let the appliance be used by children, unauthorised staff or staff who have not read and fully understood the contents of this handbook.



Before performing any maintenance operation, the authorised service engineer must switch off the machine switch and unplug the machine or open the disconnector.



For all cleaning operations comply exclusively with the instructions given in this booklet.

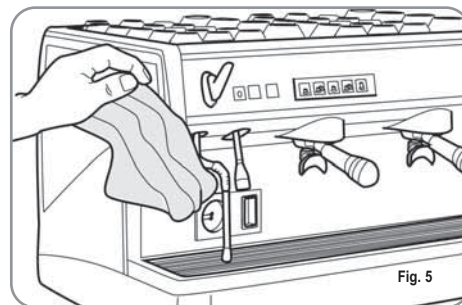

If the appliance breaks down or fails to work properly, switch it off. Any intervention is strictly forbidden. Contact qualified experts only. Repairs should only be made by the manufacturer or authorized service centres. Only original spare parts must be used. Failure to observe the above, could make the appliance unsafe.



For installation, the qualified electrician must fit an omnipolar switch in accordance with the safety regulations in force and with 3 (0,12) or more mm (in) between contacts.



To avoid dangerous overheating, make sure the supply cord is fully uncoiled.

Do not obstruct the extraction and/or dissipator grids, especially of the cup warmer.

The user must not replace the appliance supply cord. If the cord is damaged, switch off the appliance and have a qualified technician change the cord.

Single-phase appliances with current above 15 A and three-phase appliances sold without plugs are directly wired to the mains power and therefore, it is not possible to use a plug.

If no longer using the appliance, we recommend making it inoperative; after removing the plug from the mains electricity, cut the power supply cable.

CAUTION
RISK OF POLLUTION

Do not dispose of the machine in the environment: to dispose of the machine, use an authorised centre, or contact the manufacturer for relative information.

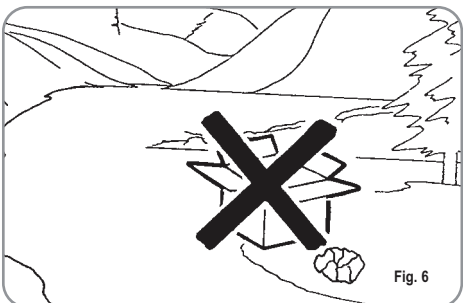

CAUTION
RISK OF INTOXICATION

Use the steam nozzle with care and never place hands below the jet of steam. Do not touch the nozzle immediately after use.

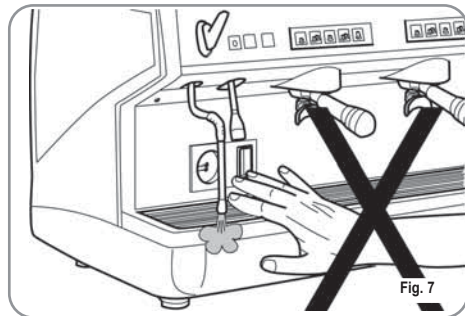

CAUTION
RISK OF BURNS OR SCALDING

We remind you that before carrying out any installation, maintenance, unloading or adjustment operations, the qualified operator must put on work gloves and protective footwear.

The maximum noise disturbance level is lower than 70db.

If the pipe connecting to the mains water is replaced the old pipe must never be re-used.

CAUTION

INFORMATION TO THE USERS

Under the senses of art. 13 of Law Decree 25th July 2005, n. 151 "Implementation of the Directives/ Guidelines 2002/95/CE, 2002/96/CE and 2003/108/CE, concerning the reduction of the use of dangerous substances in electric and electronic equipment, as well as the disposal of wastes".

The symbol of the crossed large rubbish container that is present on the machine points out that the product at the end of its life cycle must be collected separately from the other wastes. The user for this reason will have to give the equipment that got to its life cycle to the suitable separate waste collection centres of electronic and electrotechnical wastes, or to give it back to the seller or dealer when buying a new equipment of equivalent type, in terms of one to one. The suitable separate waste collection for the following sending of the disused equipment to recycling, the dealing or handling and compatible environment disposal contributes to avoid possible negative effects on the environment and on the people's health and helps the recycling of the materials the machine is composed of. The user's illegal disposal of the product implies the application of administrative fines as stated in Law Decree n.22/1997" (article 50 and followings of the Law Decree n.22/1997).

3. TRANSPORT AND HANDLING

3.1 MACHINE IDENTIFICATION

Always quote the machine serial number in all communications to the manufacturer, Nuova Simonelli.



3.2 TRANSPORT

The machine is transported on pallets which also contain other machines - all boxed and secured to the pallet with supports.

Prior to carrying out any transport or handling operation, the operator must:

- put on work gloves and protective footwear, as well as a set of overalls which must be elasticated at the wrists and ankles.

The pallet must be transported using a suitable means for lifting (e.g., forklift).

3.3 HANDLING



CAUTION

RISK OF IMPACT OR CRASHING

During all handling operations, the operator must ensure that there are no persons, objects or property in the handling area.

The pallet must be slowly raised to a height of 30 cm (11,8 in) and moved to the loading area. After first ensuring that there are no persons, objects or property, loading operations can be carried out.

Upon arrival at the destination and after ensuring that there are no persons, objects or property in the unloading area, the proper lifting equipment (e.g. forklift) should be used to lower the pallet to the ground and then to move it (at approx. 30 cm (11,8 in) from ground level), to the storage area.



CAUTION

RISK OF IMPACT OR CRASHING

Before carrying out the following operation, the load must be checked to ensure that it is in the correct position and that, when the supports are cut, it will not fall.

The operator, who must first put on work gloves and protective footwear, will proceed to cut the supports and to storing the product. To carry out this operation, the technical characteristics of the product must be consulted in order to know the weight of the machine and to store it accordingly.

4. INSTALLATION AND PRELIMINARY OPERATIONS

After unpacking, assess that the machine and its accessories unit are complete, then proceed as follows:

- place the machine so that it is level on a flat surface;
- assemble its supporting feet by inserting the insert into the cylindrical unit;
- twist the rubber foot into the screw thread inside the unit;
- screw the whole assembled unit into the allotted setting for the machine's adjustable feet;
- level the machine by regulating the adjustable feet;

NOTE: the unit grooves have to face upwards, as shown in the following illustration.

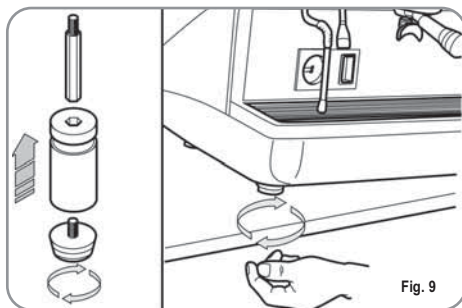

Fig. 9

It is advisable to install a softener (1) and then a mesh filter (2) on the external part of the plumbing system, during preliminaries and after levelling the machine. In this way impurities like sand, particles of calcium, rust etc will not damage the delicate graphite surfaces and durability will be guaranteed. Following these operations, connect the plumbing systems as illustrated in the following figure.



WARNING

Recommended mains pressure for the water is [2.3] bar.



WARNING

Avoid throttling in the connecting tubes. Assess that the drain pipe (3) is able to eliminate waste.

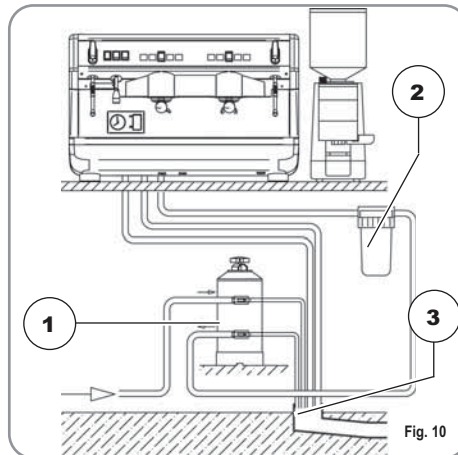

Fig. 10

KEY

- 1 Softener
- 2 Mesh filter
- 3 Drain Ø 50 mm

NOTE: For a correct functioning of the machine the water works pressure must not exceed 4 bars.

Otherwise install a pressure reducer upstream of the softener; the internal diameter of water entrance tube must not be less than 6mm ($\frac{3}{8}$ ").



CAUTION
RISK OF SHORT CIRCUITS

The machine must always be protected by an automatic omnipolar switch of suitable power with contact openings of equal distance or more than 3mm.

Nuova Simonelli is not liable for any damage to people or objects due to not observing current security measures.

Prior to connecting the machine to the electrical mains, assess that the voltage shown on the machine's data plate corresponds with that of the mains.

If it does not, carry out the connections on the basis of the available electrical line, as follows:

- for **V 380 / 3 phases voltage +Neutral:**

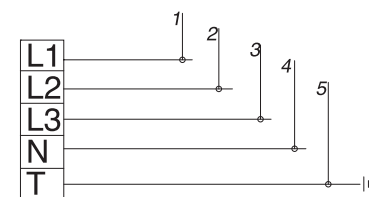

Fig. 11

- for **V 230 / monophase voltage**

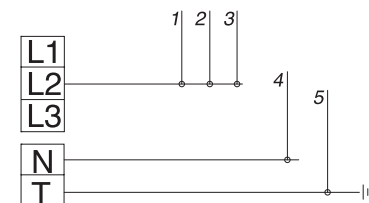

Fig. 12

KEY

- | | |
|---------|----------------|
| 1 Black | 4 Blue |
| 2 Grey | 5 Yellow-green |
| 3 Brown | |

NOTE: At the start of the day's activities and in any case, if there are any pauses of more than 8 hours, then it is necessary to change 100% of the water in the circuits, using the relevant dispensers.

NOTE: In case of use where service is continuous, make the above changes at least once a week.

5. ADJUSTMENTS TO BE MADE BY A QUALIFIED TECHNICIAN ONLY



CAUTION

The adjustments listed here below must **ONLY** be performed by a Specialist Technical Engineer.

Nuova Simonelli cannot be held liable for any damage to persons or property arising from failure to observe the safety instructions supplied in this manual.



CAUTION
ELECTRIC SHOCK HAZARD

Before performing any operation, the specialist technical engineer must first switch off the main switch off and unplug the machine.

5.1 FILLING BOILER MANUALLY

All models *Appia* are equipped with a level gauge to keep the water level inside the boiler constant.

When using the machine for the first time, it is advisable to fill the boiler by hand to avoid damaging the electrical resistor and turning on the electronic protection.

If this should happen, just turn the machine off and then start it up again to complete its loading procedure (see chapter "MACHINE FUNCTIONS MESSAGE – LEVEL ERROR").

To fill the boiler manually for the first time, proceed as follows:

- remove the worktop grid;

- turn the manual "A" level tap so that water will enter the boiler;
- once the maximum level has been reached, as indicated by the optical level, turn tap "A" off;

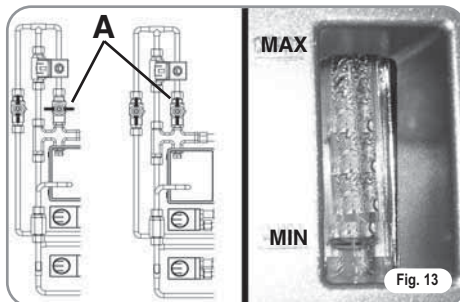

- switch the machine on by placing the general switch on "I"; this will activate the level gauge which will automatically maintain the water level inside the boiler.

5.2 PRESSOSTAT/PUMP ADJUSTMENT

To adjust the service pressure of the boiler, thus regulating the water temperature, according to the various functions and needs of the coffee desired, proceed as follows:

- remove the worktop grid cover;
- remove the protective metal sheet by unscrewing the two side screws (A) as shown in the following illustration;



- turn the pump registration screw, turning it clockwise to INCREASE and counter clockwise to DECREASE the pressure.

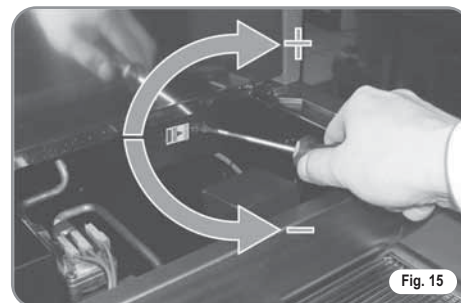

Advisable pressure: 1 - 1,4 bar
(according to the kind of coffee).

- turn the pump registration screw, turning it clockwise to INCREASE and counter clockwise to DECREASE the pressure.

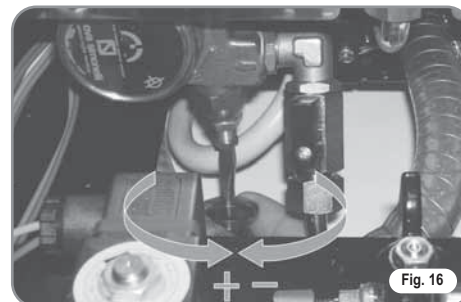

Advisable pressure: 9 bar.

- The set pump pressure is shown on the lower part of the gauge.

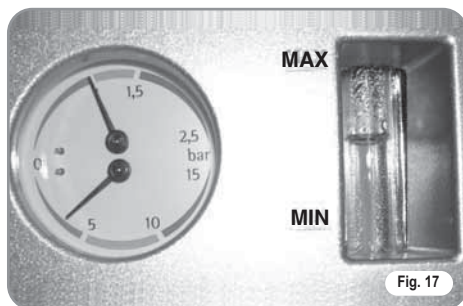

Once the adjustment operation has been completed, screw the protective metal sheet back into its setting and replace the worktop grid cover.

5.3 HOT WATER ECONOMISER ADJUSTMENT (optional V/ESSE model)

All *Appia* models are fitted with a hot water mixer that can be used to adjust the delivery temperature of the water and therefore, to optimise system performance.

To adjust the hot water economiser, it is necessary to remove the left-hand panel of the machine, proceeding as follows:

- loosen the two top screws (Fig. 18);



- loosen the screw beside the steam nozzle A;
- press the knob B and remove the left-hand panel.

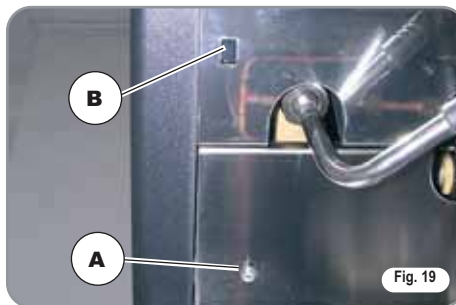

- to adjust the temperature of the hot water delivered from the nozzle, turn the register knob CLOCKWISE / ANTICLOCKWISE to INCREASE / REDUCE the temperature;



- when this operation is complete, fit the left-hand panel back onto the machine.

5.4 PUSH-BUTTON PANEL REPLACEMENT

For correct functioning of the machine, personalising each button panel card at time of replacement is necessary; proceed as follows on the selectors placed on the card (on the key side).

GROUP	sw1	sw2	sw3	sw4	sw5	sw6
Group 1	On	Off	Off	On	Off	Off
Group 2	Off	On	Off	Off	On	Off
Group 3	Off	Off	On	Off	Off	On

6. USE

Before starting to use the appliance, the operator must be sure to have read and understood the safety prescriptions contained in this booklet.



6.1 APPIA V

6.1.1 SWITCHING THE MACHINE ON

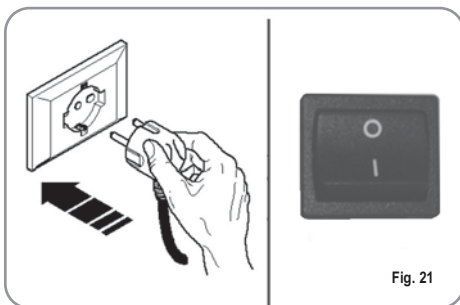
- Plug the machine into the mains power socket.
- Set the main switch (no. 13, Fig 1) to "ON".



The LED of the on key  will begin to flash.

Hold down the on key  for 5 seconds. At this point, the Flash-test will begin; this is where all LEDs are switched on for three seconds, after which the test is complete and the hot water key  will switch off.

The fact that the machine is operating is shown by the LED of the on switch  and all delivery keys, which remain lit.

NOTE: all selection keys are enabled from the end of the diagnostic operation.



When servicing the electronic machine card, switch off the machine using the external main switch and unplug the power cord.

6.1.2 SWITCHING THE MACHINE OFF

- To switch off the machine, hold down the on/off key  for about 2 seconds.

The machine will switch off and the LED on the on/off key  will start to flash again.

- Set the main switch to "OFF".

6.2 APPIA ESSE

6.2.1 SWITCHING THE MACHINE ON

- Plug the machine into the mains power socket and set the main switch to "I".

6.2.2 SWITCHING THE MACHINE OFF

- Set the main switch to "O".

6.3 SELECTION CONFIGURATION

Set the desired function on the available keys placed above the filter-holders (see chapter "DESCRIPTION").



BUTTONS KEY (Selection configuration)



1 small coffee



2 small coffees



1 long coffee



2 long coffees



Continuous

6.4 MAKING COFFEE

Unhitch the filter-holder and fill it with one or two doses of ground coffee depending on the filter used.

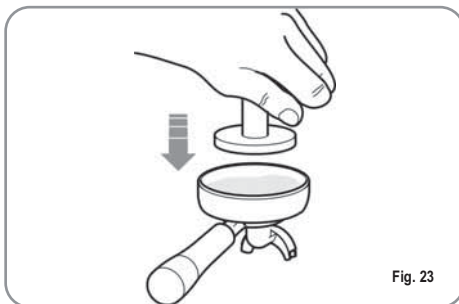

Fig. 23

Press the coffee with the provided coffee presser, dust off any coffee residue from the rim of the filter (this way the rubber gasket will last longer).

Insert the filter in its unit.

Press the desired coffee button:



1 small coffee



2 small coffees



1 Caffè lungo



2 long coffees

By starting up the coffee brewing procedure the unit's pump is activated and the unit's solenoid valve is opened.

By pressing it, the button will turn on and signal the operation

NOTE: when in pause, leave the filter-holder inserted in the unit so that it will keep warm. To guarantee the utmost thermic stability during use, the delivery units are thermo-compensated with complete hot water circulation.

6.5 USING STEAM



CAUTION
RISK OF BURNS OR SCALDING

While using the steam nozzle, you must pay attention to not place your hands beneath it or touch just after it has been used.

To use steam just pull or push the provided lever (Fig. 24).

By pulling it completely the lever will hold a position of maximum delivery; by pushing it, the lever will automatically give way.

The two steam nozzles are articulated to guarantee their easy use.



NOTE: Before using the steam wand, always bleed out any condensation for at least 2 seconds or according to the manufacturer's instructions.

6.6 MAKING CAPPUCCINO

To obtain the typical cappuccino foam, immerse the nozzle all the way into a container 1/3

full of milk (preferably cone-shaped). Turn on the steam. Before the milk starts to boil, pull the nozzle slightly up and lightly move it vertically across the surface of the milk. When you have completed the procedure, clean the nozzle carefully with a soft cloth.

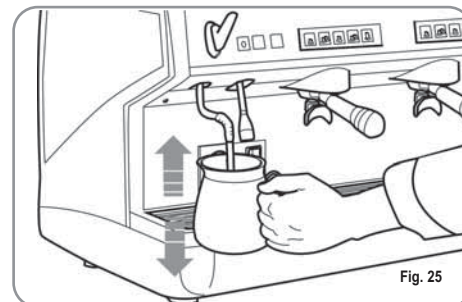

Fig. 25

6.7 HOT WATER SELECTION



CAUTION
RISK OF BURNS OR SCALDING

While using the hot water nozzle, pay careful attention not to place your hands beneath it or touch it just after it has been used.

This nozzle delivers hot water to make tea or herb teas.

Place a container underneath the hot water nozzle and press the switch (ESSE model) or press the hot water select button (V model).



Make sure the button lights up.

Water will be delivered from the hot water nozzle for as long as the set time indicates.

NOTE: Hot water can be delivered at the same time as coffee.

7. PROGRAMMING *Appia V*

7.1 PROGRAMMING DOSES

To access the programming units, proceed as follows:

NOTE: the procedure can be carried out with the machine on.

- To enter the programming function for each group, it is necessary to hold down the continued delivery key  for 5 seconds

- The delivery keys will begin to flash.
- Accessing the programming mode for the first group also enables the setting mode for the machine's operating parameters.

7.2 PROGRAMMING COFFEE DOSES

To programme the amount of water for each of the delivery keys, proceed as follows:

- fill the filter holder with the right amount of coffee (the double or single filter holder can be used, according to the key to be programmed).
- Place the filter holder in the group.
- Press one of the delivery keys:



- The machine will begin to dispense and once the required quantity has been delivered, press the continued key .

- Delivery will cease and the selected dose key will switch off (the other keys will continue to flash).



- Press the continued key  to exit the programming function or to continue programming other dose keys

NOTE: This procedure can be used for all groups on the machine, although it must be performed on one group at a time; the other groups will continue to operate as normal.

7.3 PROGRAMMING HOT WATER

- Use the relevant procedure to enter the programming function.
- Press the hot water selection key .

- Hot water delivery will begin.
- Decide the required amount of hot water and then press the  key again



- Press the continued key  to exit the programming function or to continue programming other selection keys.





7.4 PROGRAMMING THE CUP WARMER (optional)

- Enter the programming mode for the first group following the usual procedure.
- Press the cup warmer select key .

- The delivery buttons for the first and second group will respectively show the automatic switch on and off times, while the continuous keys  for the first and second group

will flash.

As shown in the table, each of the delivery keys has an associated value; the switch on time for the cup warmer is given by summing the values for the lit keys of the first group. The same calculation method is used for the switch off time of the cup warmer, using the keys of the second group.

Key	Group 1 (on time)	Group 2 (off time)
	2 min.	5 min.
	4 min.	10 min.
	8 min.	20 min.
	16 min.	40 min.

7.5 PROGRAMMING STANDARD DOSES

- It is possible to enter pre-set values for the 4 group doses and water (steam).

To do this, it is necessary to press the key  and hold it down for at least 10

seconds until the flashing keys switch off.

The doses are:

1CN	2CN	1CL	2CL
40 cc	60 cc	50 cc	85 cc

WATER
9 sec.

NOTE: A time setting of 0 seconds for steam and water means this function will work continually.

7.6 COPYING DOSE SETTINGS

It is possible to copy the dose settings for group 1 to groups 2 or 3.



To do this, hold down the continuous key  of the group 2 or 3 for at least 8

seconds until the keys stop flashing.

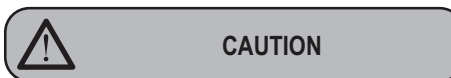
7.7 PROGRAMMING OPERATING PARAMETERS





The adjustments listed here below must **ONLY** be performed by a Specialist Technical Engineer

If you hold down the  key of the second group, after first entering the programming mode for the first group, this will access the machine parameters setting mode; this is signalled by the continuous key  for

the second group, which will switch on.

- Enabling the pump if the level is enabled.
- Enabling the software block to enter the dose programming function.
- Adjusting keypad brightness.
- Enabling the hot water pump (on machines fitted with economiser).
- Disabling the cup warmer
- Restoring default settings.

1. Enabling the pump during levelling.

Use the espresso key  to set pump enabling during levelling: if the key  is lit, the pump is enabled

together with the level; if it is switched off, the pump is not enabled with the level function.

2. Enabling the software block to enter the dose programming function.

Use the long coffee key  to enable a software block to programme doses (key lit) or to de-activate the block (key off).

3. Adjusting keypad brightness..

The 2 long coffees key  of the second group is used to choose the key brightness setting from 5 pre-set levels.

Use the  key, which will flash, to change the level, lowering it to minimum or returning it to maximum.

4. Enabling the hot water pump (machines fitted with economiser only).

Use the hot water key  to set the pump to switch on while hot water is being delivered.

If the  key is lit, the pump will switch on while hot water is being delivered; if it is switched off, the pump will not switch on.

5. Disabling the cup warmer..

Use the  key to enable or disable cup warmer operation. If the key is lit, the cup warmer will operate normally as set during programming; if the key is switched off, the cup warmer is disabled.

If the cup warmer is not enabled, the



key will only switch on during the Flash-test, after which this key will have no effect when pressed.



Press the continuous key of the second group to store the modified values and exit the page for setting machine operating parameters.

6. Restoring default settings

It is possible to restore default settings, i.e. pump level, water with pump, maximum brightness and cup warmer enabled.

To restore these parameters, it is sufficient to switch on the machine using the



key

then to press the 2 espressos



and 2 long coffees



keys of the first group at

the same time.

7.8 AUTOMATIC GROUP CLEANING CYCLE

To enter the automatic cleaning mode, switch the machine off and then on again, holding down the hot water



and cup warmer



keys during the initial Flash-test.

At the end of the Flash-test, the



and



keys and the single long coffee key



of all groups will begin to flash.



Press the key to start the washing cycle for the relevant group.

Once the washing cycle has been completed, it is possible to perform a rinse cycle for the same group by pressing the



key again.

To perform the rinse cycle at a later time, switch off the machine and the card will store any cleaning cycles that need to be completed in its memory. In fact, the next time that the machine is switched on, the machine card will automatically open the group cleaning status without it being necessary to press the



and



keys for 2 seconds to exit the cleaning mode in the event that there are no cycles to be completed. For incomplete cycles, the



keys of the

groups that require rinsing will continue to flash.

Hold down the



and



keys for 2 seconds more to force exit from the cleaning mode, resetting all information about rinse cycles still to be completed.

When a cleaning cycle is complete, the



key for the group will switch off.

If there are no more rinse cycles to be performed, the card will exit the cleaning mode.

8. CLEANING AND MAINTENANCE

During maintenance/repairs, the parts used must be able to guarantee compliance with the safety and hygiene requirements envisaged for the device.

Original replacement parts can offer this guarantee. After repairs to/replacement of a part that comes into contact with foods or water, it is necessary to carry out a washing procedure or to follow the steps indicated by the manufacturer.

8.1 STOPPING THE MACHINE

To stop the machine, press the main switch and set it to OFF.



Fig. 26

8.2 CLEANING THE OUTSIDE OF THE MACHINE

The machine must be set to "O" power (switch off and disconnecter open) before any cleaning operations are performed.



WARNING

Do not use solvents, chlorine-based products or abrasives.



WARNING

It is not possible to clean the machine using water jets or standing it in water.

Cleaning the work area: remove the worktop, lifting it up from the front and sliding it out. Remove the water collection dish underneath and clean everything with hot water and cleansers.

Cleaning the bottom: To clean all the chromium-plated areas, use a soft, damp cloth.

8.3 CLEANING THE STAINLESS COFFEE-HOLDERS

The stainless coffee-holders are situated under the delivery units, as shown in figure.



Fig. 27

NOTE: To clean proceed as follows:

- Turn the screw placed in the centre of the coffee-holder.
- Slide the coffee-holder out and check that its holes are not obstructed but clean.
- If obstructed, clean as described (Paragraph "CLEANING FILTERS AND FILTER-HOLDERS")

We recommend cleaning the coffee-holder once a week.

8.4 CLEANING THE UNIT WITH THE AID OF THE BLIND FILTER

The machine is pre-set for cleaning the delivery unit with a specific washing powder.

We recommend carrying out a washing cycle at least once a day with special cleansers.

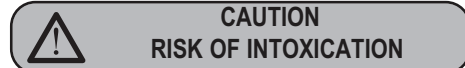

CAUTION RISK OF INTOXICATION

Once the filter-holder has been removed, repeat delivery operations a few times to eliminate any cleanser residues.

Per eseguire la procedura di lavaggio procedere come segue:

- 1) Sostituire il filtro con quello cieco del gruppo erogatore.
- 2) Mettervi all'interno due cucchiaini di detergente specifico in polvere e immettere il portafiltro al gruppo.
- 3) Premere uno dei tasti caffè e arrestare dopo 10 sec. .
- 4) Ripetere l'operazione più volte.
- 5) Togliere i portafiltro ed effettuare alcune erogazioni.

8.5 CLEANING FILTERS AND FILTER-HOLDERS

Place two spoonfuls of special cleanser in half a litre of hot water and immerse filter and filter-holder (without its handle) in it leaving them to soak for at least half an hour. Then rinse abundantly with running water.

8.6 RESIN AND SOFTENER REGENERATION

To avoid scaling deposits in the boiler and in the heating exchangers, the softener must always be kept efficient. Therefore, the ionic resins must be regularly regenerated.

Regeneration times are established according to the quantity of coffee delivered daily and the hardness of the water utilised.

As an indication, regeneration times can be calculated on the basis diagram illustrated in Fig. 28.

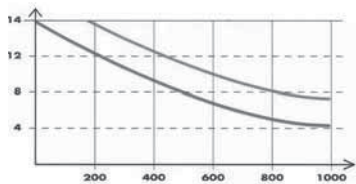

Fig. 28

Regeneration procedures are as follows:

1) Turn the machine off and place a container large enough to contain at least 5 litres under tube E (Fig. 29).

Turn levers C and D from left to right; take the cap off by unscrewing knob and fill with 1 Kg normal kitchen salt (Fig. 30).

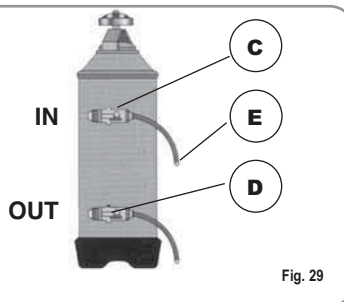

Fig. 29

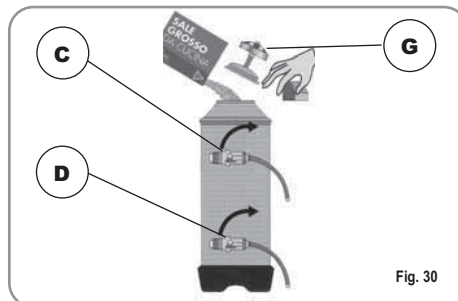

Fig. 30

2) Put the cap back on and reposition lever C moving it towards the left (Fig. 31) and allowing tube F to discharge the salty water until it has been eliminated and the water becomes fresh again (about half an hour).

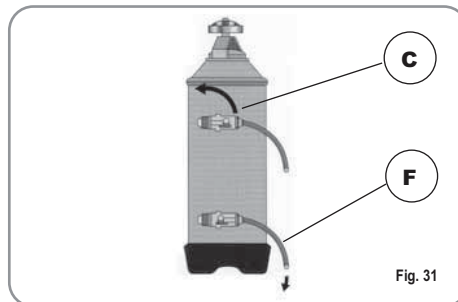

Fig. 31

3) Reposition lever D towards the left (Fig. 32).

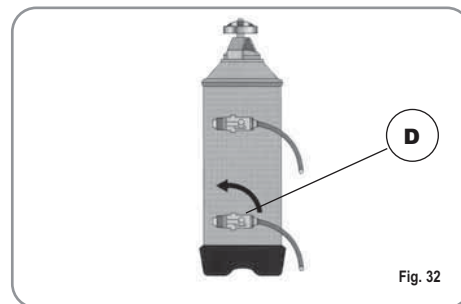





Fig. 32

9. Appia V MACHINE FUNCTION MESSAGES

DISPLAY AND KEY INDICATIONS	CAUSE	EFFECT	SOLUTION	NOTES
Drawing of continued key  flas hing and delivery key  lit.	If the doser doesn't send out its set commands within the first three seconds from delivery onset.	If the delivery isn't manually halted, the maximum time limit (120 sec) will be blocked.	Interrupt delivery.	
Drawing of continued key  flashing.	If within 90 sec. from onset, with pump inserted during the levelling, at 180 sec., if the level has not been re-established.	The pump, the resistor and all the functions will be halted.	Turn the machine off for at least 5 sec. and then switch it on again.	

NOTES:

Dotted lines for writing notes.

Appia[®]
MADE IN ITALY

IMPIANTO ELETTRICO /ELECTRIC SYSTEM Appia ESSE 2/3 GR.

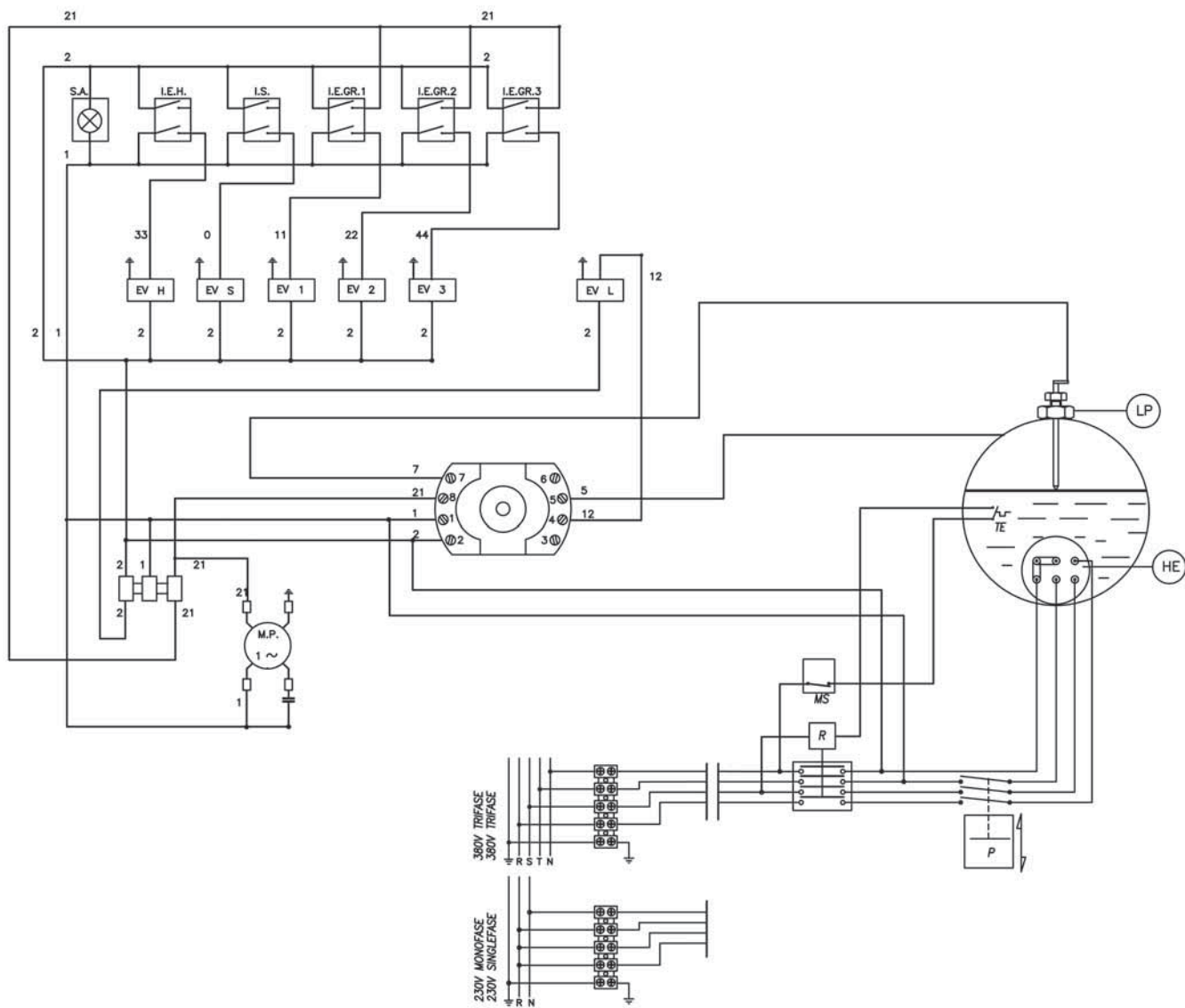

Fig. 33

IMPIANTO ELETTRICO /ELECTRIC SYSTEM Appia ESSE 2/3 GR.

LEGENDA

EV H
 Elettrovalvola vapore/acqua calda
EV S
 Elettrovalvola scaldatazze
EV1-2-3
 Elettrovalvola erogazione gruppo
MP
 Motore pompa
I.S
 Interruttore scaldatazze
I.E.H.
 Interruttore acqua calda
I.E.GR.1-2-3
 Interruttore gruppo 1-2-3
R
 Relè
P
 Pressostato
EV L
 Elettrovalvola livello
MS
 Interruttore generale
HE
 Resistenza
LP
 Sonda livello
TE
 Termostato sicurezza
S.A.
 Lampada spia

KEY

EV H
 Steam / hot water solenoid valve
EV S
 Cup warmer solenoid valve
EV1-2-3
 Group delivery solenoid valve
MP
 Pump motor
I.S
 Cup warmer switch
I.E.H.
 Hot water switch
I.E.GR.1-2-3
 Switch for groups 1-2-3
R
 Relay switch
P
 Pressure switch
EV L
 Level solenoid valve
MS
 Main switch
HE
 Heating element
LP
 Level probe
TE
 Safety thermostat
S.A.
 Indicator light

IMPIANTO ELETTRICO /ELECTRIC SYSTEM *Appia V 2 GR.*

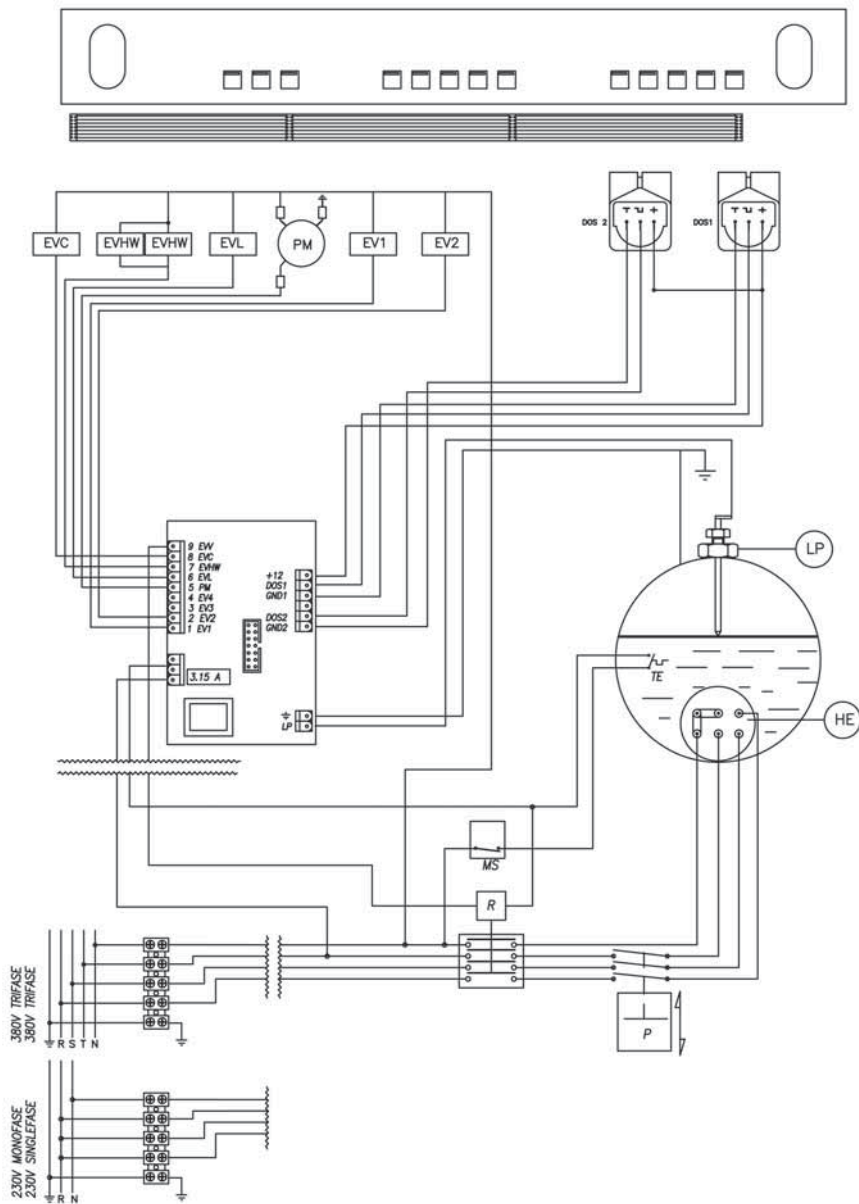

Fig. 34

IMPIANTO ELETTRICO /ELECTRIC SYSTEM Appia V 2 GR.

LEGENDA

EVC

Elettrovalvola scaldacqua

EVHW

Elettrovalvola miscelatore
acqua calda

EV L

Elettrovalvola livello

EV1-2-3

Elettrovalvola erogazione
gruppo

PM

Motore pompa

Dose

Ventolino

HE

Resistenza

LP

Sonda livello

TE

Termostato sicurezza

R

Relè

P

Pressostato

MS

Interruttore generale

TP

Sonda temperatura

KEY

EVC

Cup warmer solenoid valve

EVHW

Hot water mixer solenoid
valve

EV L

Level solenoid valve

EV1-2-3

Group delivery solenoid
valve

PM

Pump motor

Dose

Fan

HE

Heating element

LP

Level probe

TE

Safety thermostat

R

Relay switch

P

Pressure switch

MS

Main switch

TP

Sonda temperatura

IMPIANTO ELETTRICO /ELECTRIC SYSTEM *Appia V 3 GR.*

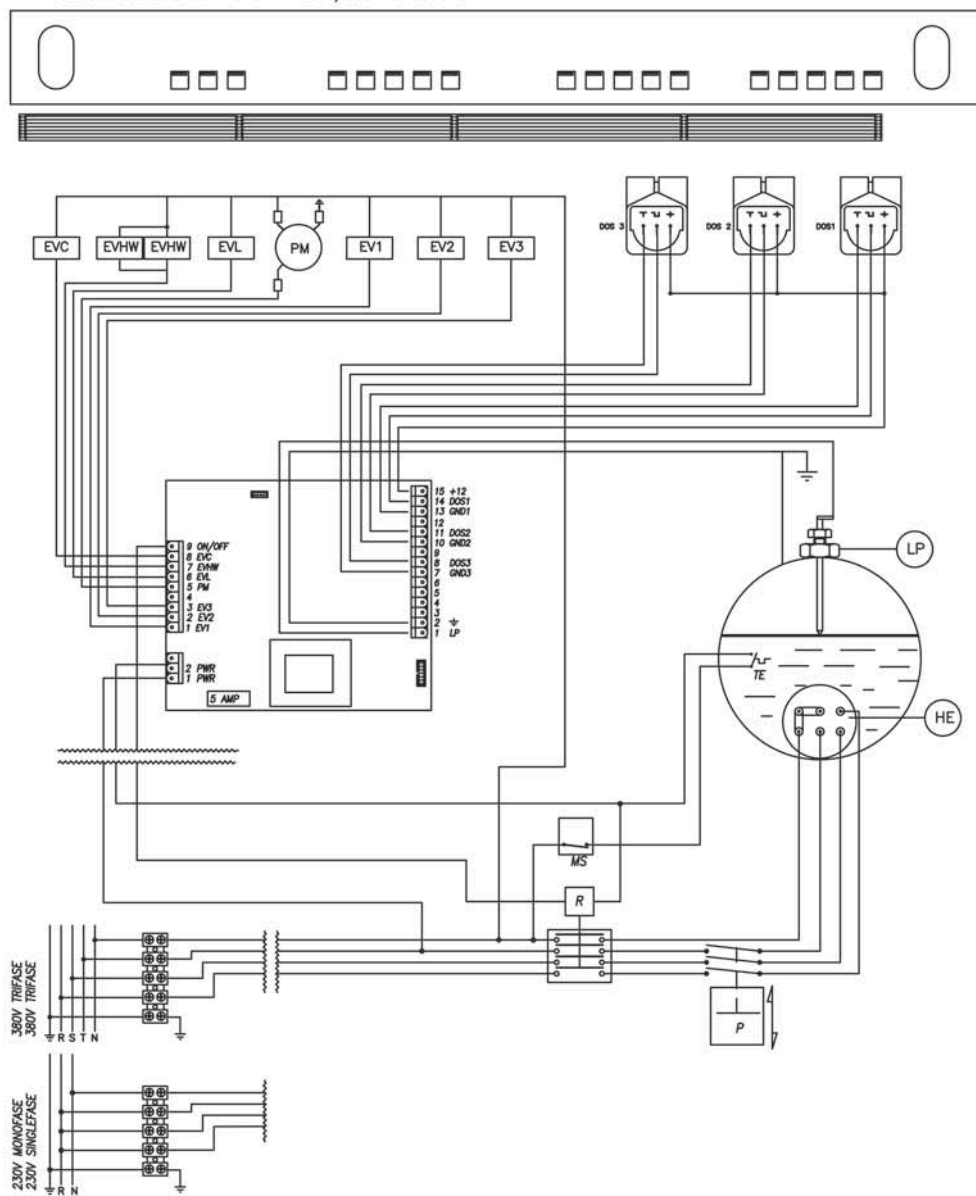

Fig. 35

IMPIANTO ELETTRICO /ELECTRIC SYSTEM *Appia V 3 GR.*

LEGENDA

EVC

Elettrovalvola scaldacqua

EVHW

Elettrovalvola miscelatore acqua calda

EV L

Elettrovalvola livello

EV1-2-3

Elettrovalvola erogazione gruppo

PM

Motore pompa

Dose

Ventolino

HE

Resistenza

LP

Sonda livello

TE

Termostato sicurezza

R

Relè

P

Pressostato

MS

Interruttore generale

TP

Sonda temperatura

KEY

EVC

Cup warmer solenoid valve

EVHW

Hot water mixer solenoid valve

EV L

Level solenoid valve

EV1-2-3

Group delivery solenoid valve

PM

Pump motor

Dose

Fan

HE

Heating element

LP

Level probe

TE

Safety thermostat

R

Relay switch

P

Pressure switch

MS

Main switch

TP

Sonda temperatura

IMPIANTO IDRAULICO / PLUMBING SYSTEM

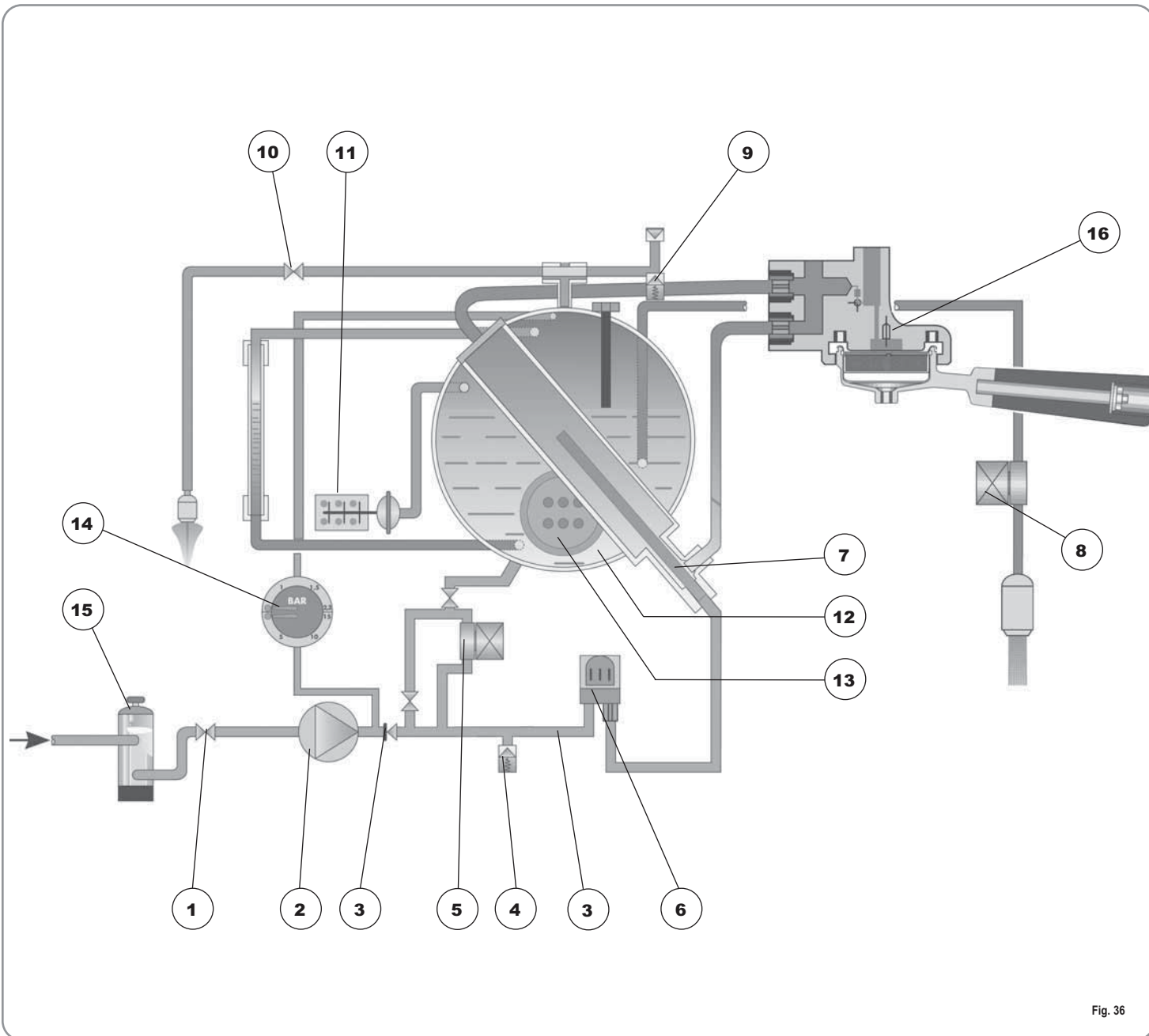

Fig. 36

IMPIANTO IDRAULICO /PLUMBING SYSTEM

LEGENDA

- 1** Rubinetto ingresso acqua
- 2** Pompa
- 3** Valvola di ritegno
- 4** Valvola di espansione
- 5** Elettrovalvola di livello
- 6** Dosatore volumetrico
- 7** Scambiatore di calore
- 8** Elettrovalvola erogazione
- 9** Valvola di sicurezza cald.
- 10** Rubinetto vapore
- 11** Pressostato
- 12** Caldaia
- 13** Resistenza
- 14** Manometro doppia scala
- 15** Depuratore
- 16** Gruppo erogatore

KEY

- 1** Water entrance faucet
- 2** Pump
- 3** Retaining valve
- 4** Expansion valve
- 5** Refill electrovalve
- 6** Flowmeter
- 7** Heat exchanger
- 8** Delivery electrovalve
- 9** Heater safety valve
- 10** Steam tap
- 11** Pressostat
- 12** Boiler
- 13** Heating element
- 14** Double scale gauge
- 15** Purifier
- 16** Delivery unit



Nuova Distribution Centre
LLC 6940Salashan PKWY BLDG A 98248
Ferdale, WA
Tel. +1.360.3662226
Fax +1.3603664015
videoconf.+1.360.3188595
www.nuovasilmonelli.it
info@nuovasilmonelli.com



Via M. d'Antegiano, 6
62020 Belforte del Chienti
Macerata Italy
Tel. +39.0733.9501
Fax +39.0733-950242
www.nuovasilmonelli.it
E-mail: n.simonelli@nuovasilmonelli.it



nuova

SIMONELLI®

espresso coffee machines



Appia®
MADE IN ITALY

MANUEL D'INSTRUCTIONS GEBRAUCHANWEISUNGEN

INSTRUCCIONES DE MANEJO

DICHIARAZIONE DI CONFORMITÀ CE
EC DECLARATION OF CONFORMITY



nuova simonelli
espresso coffee machines

Via M. D'Antegiano, 6 - 62031 Belforte del Chienti (MC)

dichiariamo, sotto la nostra responsabilità, che il prodotto:
declare under our responsibility that the product:

MACCHINE PER CAFFÈ ESPRESSO
MODELLI: Appia - versioni V, Esse.

ESPRESSO COFFEE MACHINES
MODELS: Appia - versions V, Esse.

al quale si riferisce questa dichiarazione, è costruito in conformità alle disposizioni:
to which this declaration relates, following the provisions of the Directives:

EN 60335-2-75:2004 + A1:2005 + A11:2006
in combination with
EN 60335-1:2002 + A1:2004 + A11:2004 + A12:2006 + A2:2006
EN 50366:2003 + A1:2006

ed è conforme alle direttive
following the provisions of the Directives

2006 / 95 / CE Low Voltage
2004 / 108 / CE (EMC)

data: Novembre 2008
November 2008

nuova simonelli s.p.a.
L'Amministratore Delegato
(Ottavi Nando)

Félicitations,

Avec l'achat du modèle *Appia* vous avez fait un excellent achat. vous avez fait un excellent choix.

L'achat d'une machine à café express professionnelle regroupe plusieurs facteurs de sélection: le nom du Constructeur, les caractéristiques des fonctions de la machine, la fiabilité technique, la qualité et la rapidité du service après-vente, le coût. Vous avez donc certainement évalué tous ces critères avant de décider de choisir le modèle *Appia* .

Vous avez choisi le meilleur produit et nous sommes certains que vous le découvrirez à chaque café et à chaque cappuccino que vous boirez.

Et vous apprécierez la facilité et la rapidité d'emploi du modèle *Appia* .

Si cet achat est le premier achat d'une machine Nuova Simonelli, vous êtes le bienvenu dans le monde de la haute cafétéria; si, par contre, vous faites déjà partie de notre Clientèle, nous sommes flattés par votre fidélité, et nous vous remercions de préférer nos produits.

Salutations distinguées,

Nuova Simonelli S.p.a.



Appia[®]
MADE IN ITALY

CARACTERISTIQUES TECHNIQUES

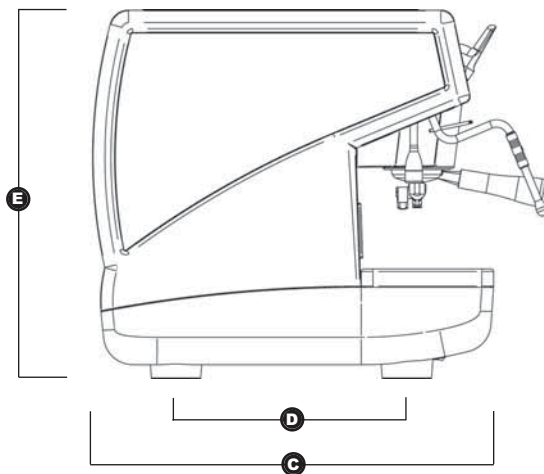
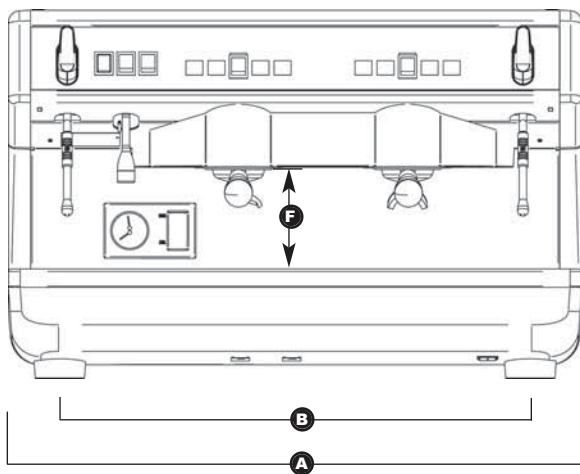

	2 Groupes		3 Groupes	
POIDS NET	60 kg	133 lb	74 kg	163 lb
POIDS BRUT	65 kg	143 lb	80 kg	176 lb
PUISS. THERMIQUE	3000 W	3000 W	5000 W	5000 W
DIMENSIONS	A 785 mm	A 30 ⁷ / ₈ "	A 1010 mm	A 39 ⁷ / ₈ "
	B 690 mm	B 27 ¹ / ₈ "	B 920 mm	B 36 ³ / ₁₆ "
	C 545 mm	C 21 ⁷ / ₁₆ "	C 545 mm	C 21 ⁷ / ₁₆ "
	D 370 mm	D 14 ⁹ / ₁₆ "	D 370 mm	D 14 ⁹ / ₁₆ "
	E 530 mm	E 20 ¹ / ₁₆ "	E 530 mm	E 20 ¹ / ₁₆ "
	F 135 mm	F 5 ¹ / ₈ "	F 135 mm	F 5 ¹ / ₈ "

Appia[®]
MADE IN ITALY

INDEX

CARACTERISTIQUES TECHNIQUES2

1.	DESCRIPTION	5
1.1	LISTE ACCESSOIRES	6
2.	PRESCRIPTIONS DE SECURITE	7
3.	TRANSPORT ET DEPLACEMENT	10
3.1	IDENTIFICATION DE LA MACHINE	10
3.2	TRANSPORT	10
3.3	DEPLACEMENT	10
4.	INSTALLATION ET OPERATIONS PRELIMINAIRES	10
5.	REGLAGES DU TECHNICIEN QUALIFIE	12
5.1	REPLISSAGE MANUEL DE LA CHAUDIERE	12
5.2	REGLAGE PRESSOSTAT / POMPE	12
5.3	REGLAGE ECONOMISEUR EAU CHAUDE (option sur la version V/ESSE)	13
5.4	REPLACEMENT DES TABLEAUX A POUSSOIRS	13
6.	UTILISATION	14
6.1	APPIA V	14
6.1.1	MISE EN MARCHÉ	14
6.1.2	ARRETT	14
6.2	APPIA ESSE	14
6.2.1	MISE EN MARCHÉ	14
6.2.2	ARRETT	14
6.3	CONFIGURATION SELECTION	14
6.4	PREPARATION DU CAFE	15
6.5	UTILISATION DE LA VAPEUR	15
6.6	PREPARATION DU CAPPUCCINO	15
6.7	SELECTION EAU CHAUDE	15
7.	PROGRAMMATION APPIA V	16
7.1	PROGRAMMATION DOSES	16
7.2	PROGRAMMATION DOSES CAFFE	16
7.3	PROGRAMMATION EAU CHAUDE	16
7.4	PROGRAMMATION CHAUFFE-TASSES (OPTION)	16
7.5	PROGRAMMATION DOSES STANDARD	17
7.6	COPIAGE DOSES	17

7.7	PROGRAMMATION PARAMETRES DE FONCTIONEMENT	17
7.8	CYCLE AUTOMATIQUE DE NETTOYAGE DES GRUPES	18
8.	NETTOYAGE ET ENTRETIEN	19
8.1	ARRET	19
8.2	NETTOYAGE DE LA CARROSSERIE	19
8.3	NETTOYAGE DES DOUCHES INOX	19
8.4	NETTOYAGE DU GROUPE AVEC L'AIDE DU FILTRE BORGNE	19
8.5	NETTOYAGE DES FILTRES ET DES SUPPORTS A FILTRES	19
8.6	REVIVIFICATION DES RESINES DE L'ADOUCCISSEUR	20
9.	MESSAGES FONCTIONS MACHINE Appia V	21

INSTALLATION ELECTRIQUE APPIA ESSE 2/3 GROUPES	68
---	-----------

INSTALLATION ELECTRIQUE APPIA V 2 GROUPES	70
--	-----------

INSTALLATION ELECTRIQUE APPIA V 3 GROUPES	72
--	-----------

INSTALLATION HYDRAULIQUE	74
---------------------------------------	-----------

Appia[®]
MADE IN ITALY

1. DESCRIPTION *Appia V - Esse*

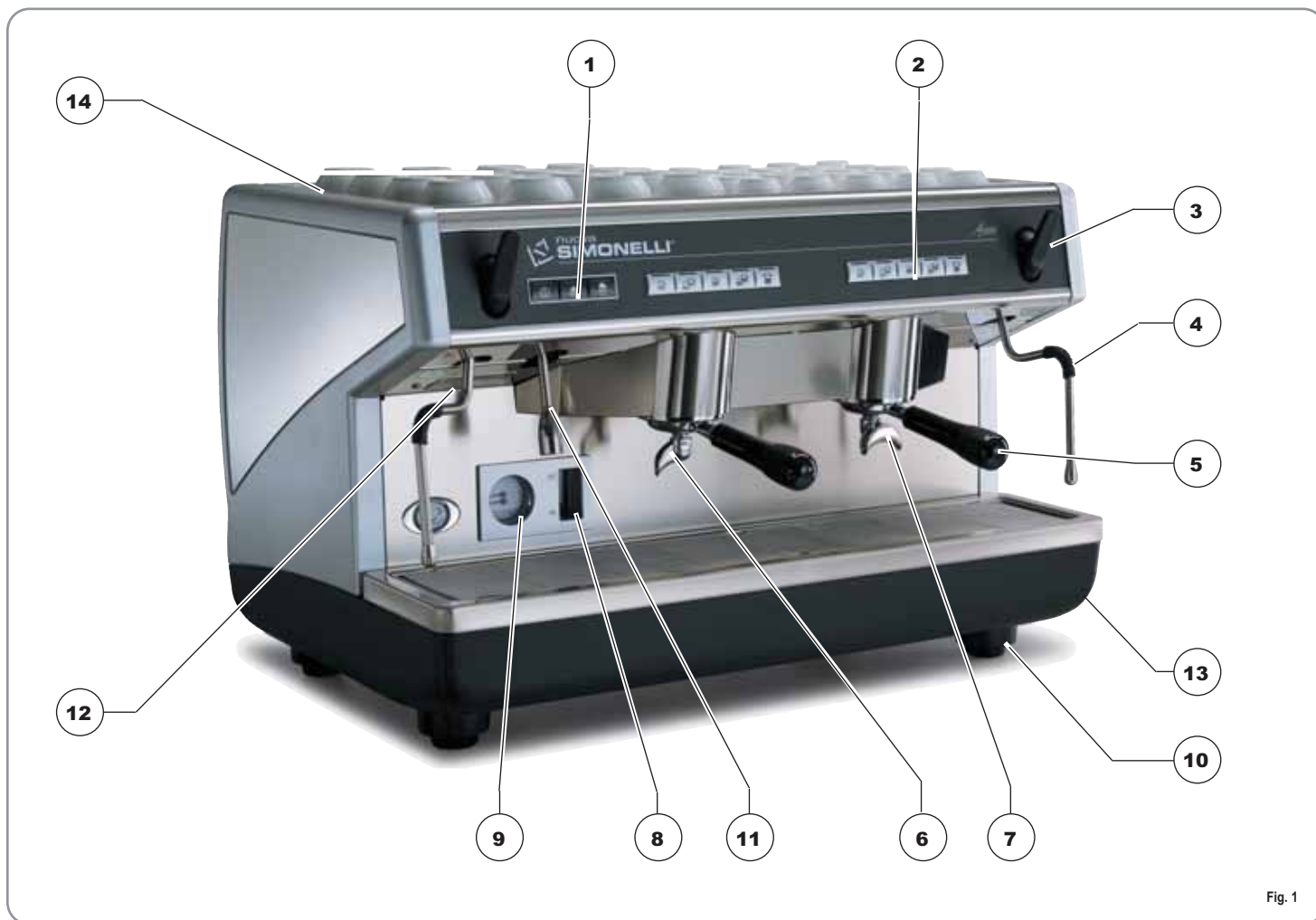
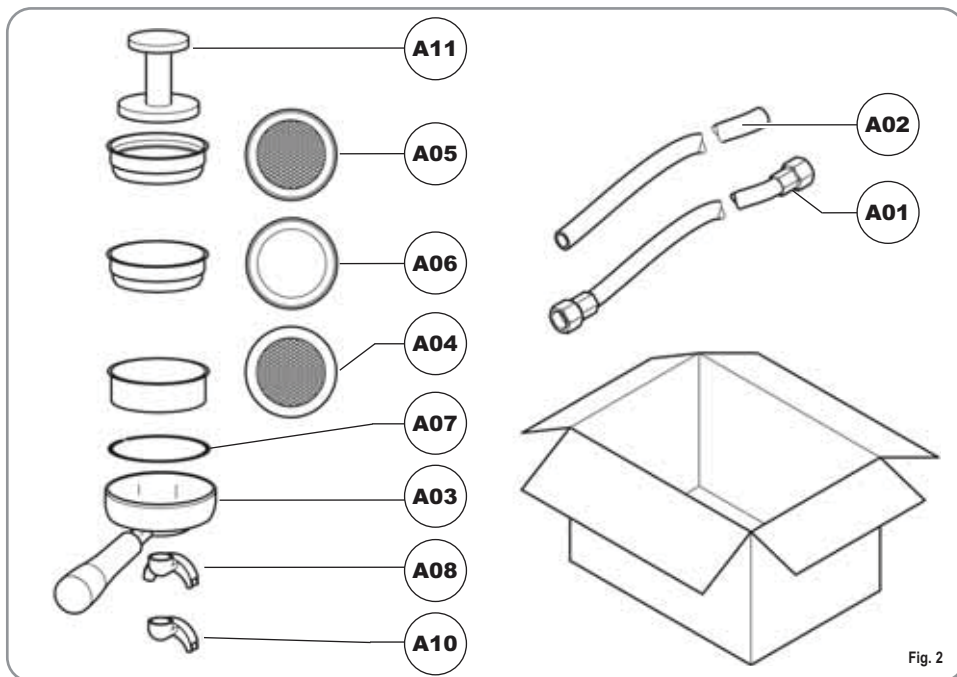

Fig. 1

LEGENDE

- | | | | |
|---|------------------------|----|-------------------------|
| 1 | Poussoirs sélection | 8 | Niveau optique |
| 2 | Poussoirs distribution | 9 | Manomètre |
| 3 | Poignée vapeur | 10 | Pied réglable |
| 4 | Lance vapeur | 11 | Lance eau chaude |
| 5 | Porte filtre | 12 | Plaquette données |
| 6 | Bec 1 café | 13 | Interrupteur général |
| 7 | Bec 2 cafés | 14 | Chauffe-tasses (option) |
| 9 | Manometro | | |

1.1 LISTE ACCESSOIRES





CODE	DESCRIPTION	2 GROUPES	3 GROUPES
A01	Tube arrivée 3/8"	1	1
A02	Tube d'évacuation Ø 25 mm - L. 150 cm	1	1
A03	Support à filtres	3	4
A04	Double filtre	2	3
A05	Filtre unique	1	1
A06	Filtre borgne	1	1
A07	Ressort	3	4
A08	Double bec de distribution	2	3
A09	Bec unique de distribution	1	1
A10	Presse café	1	1

2. PRESCRIPTIONS DE SECURITE

 Ce manuel est partie intégrante et essentielle du produit et doit par conséquent être remis à l'utilisateur. Lire attentivement les conseils qu'il contient car ils fournissent des indications particulièrement importantes sur la sécurité de l'installation, son utilisation et son entretien. Conserver ce manuel avec soin de façon à pouvoir le consulter si nécessaire.

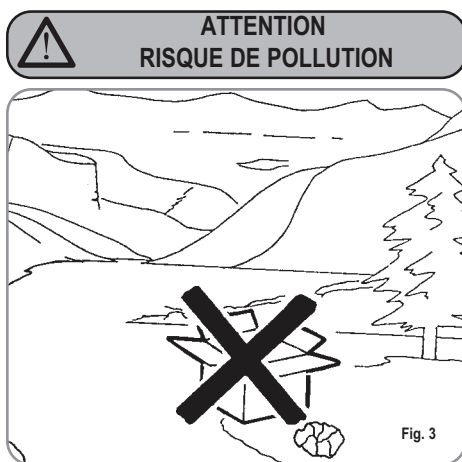
 Après avoir retiré la machine de son emballage, contrôler que l'appareil soit en parfait état. En cas du moindre doute, ne pas l'utiliser et s'adresser à un technicien qualifié. Les éléments de l'emballage (sacs plastique, polystyrène expansé, clous, etc.) ne doivent pas être laissés à la portée des enfants car ils peuvent être dangereux. Ne pas répandre ces éléments dans l'environnement.



 Avant de brancher l'appareil, veillez à ce que les données indiquées sur la plaquette correspondent à celles du réseau électrique. La plaquette est située sur le devant de l'appareil, en haut à droite. L'installation doit être réalisée dans le respect des normes en vigueur, suivant les instructions fournies par le fabricant et par un technicien qualifié.

Le fabricant ne pourra en aucun cas être retenu responsable des éventuels dommages causés par une absence de mise à la terre de l'installation. Pour la sécurité électrique de cet appareil, il est obligatoire de prévoir une installation de mise à la terre, en s'adressant à un électricien qualifié et dûment autorisé à cet effet, afin qu'il vérifie que la portée électrique de l'installation soit bien appropriée à la puissance maximum de l'appareil indiquée sur la plaquette.

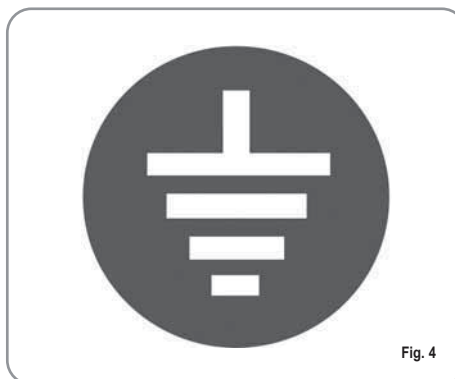



 En particulier, l'électricien devra s'assurer que la section des câbles de l'installation soit bien adaptée à la puissance absorbée par l'appareil.

L'emploi d'adaptateurs de même que de prises multiples et de rallonges est interdit. Si leur usage s'avère indispensable, il faut absolument s'adresser à un électricien dûment autorisé à cet effet.

 Pour les appareils alimentés à 220-230V, l'impédance maximum fournie par le réseau d'alimentation ne doit pas dépasser les 0,37 ohm.

 Durant l'installation du dispositif, utiliser les composants et les matériaux fournis en dotation avec le dispositif. Si l'utilisation de composants supplémentaires s'avère nécessaire, l'installateur doit vérifier l'adéquation de ces derniers pour un emploi au contact de l'eau pour la consommation humaine.

 La machine doit être installée conformément aux normes en vigueur, en matière de santé, pour les installations hydrauliques. Il faut donc que l'installation hydraulique soit réalisée par un technicien autorisé.

 L'alimentation du dispositif doit être effectuée avec de l'eau adéquate pour la consommation humaine conformément aux dispositions en vigueur dans le pays d'installation. L'installateur doit recevoir de la part du propriétaire/gérant de l'installation, une confirmation écrite indiquant que l'eau respecte les caractéristiques susmentionnées.

 Cet appareil devra être destiné uniquement à l'usage décrit expressément dans cette notice. Le fabricant ne pourra en aucun cas être retenu responsable des dommages éventuels causés par une mauvaise ou déraisonnable utilisation.

 L'appareil n'est pas indiqué pour l'utilisation de la part des enfants, des personnes avec des capacités physiques, sensorielles ou mentales réduites ou n'ayant pas l'expérience et les connaissances suffisantes, à moins qu'elles ne soient surveillées ou instruites par des personnes responsables de leur sécurité.

 Les températures maximum et minimum de stockage doivent être comprises entre $[- 5 + 50]^{\circ}\text{C}$.

 Au terme de l'installation, le dispositif doit être actionné jusqu'à ce qu'il atteigne la condition nominale de travail en le laissant en condition de "prêt au fonctionnement".

Eteindre ensuite le dispositif et vider entièrement le circuit hydraulique de sa première eau afin d'éliminer toute impureté éventuelle. Le dispositif doit être ensuite à nouveau chargé et actionné jusqu'aux conditions nominales de fonctionnement.

Lorsqu'on atteint la condition "prêt au fonctionnement", effectuer les distributions suivantes:

- 100% du circuit café à travers le distributeur de café (pour plusieurs distributeurs, diviser en mesures égales);
- 100% du circuit eau chaude à travers le distributeur d'eau (pour plusieurs distributeurs, diviser en mesures égales);

- ouverture de chaque sortie vapeur pendant 1 minute.

Au terme de l'installation, il serait préférable de rédiger un rapport des opérations effectuées.

 La température de fonctionnement doit être comprise entre $[+5, +35]^{\circ}\text{C}$.



ATTENTION

En cas de machines non équipées de fiches de branchement à la prise électrique, il est nécessaire de prédisposer le réseau avec un sectionneur qui sectionne chaque phase.

 L'utilisation de tout appareil électrique entraîne le respect de certaines règles fondamentales. Et notamment:

- ne pas toucher l'appareil avec les mains ou les pieds mouillés ou humides;



ATTENTION RISQUE DE DECHARGE ELECTRIQUE

- ne pas utiliser l'appareil pieds nus;
- ne pas employer de rallonges dans des locaux utilisés comme salle de bain ou douche;
- ne pas tirer le câble d'alimentation pour débrancher l'appareil du réseau électrique; rete di alimentazione;

- ne pas laisser l'appareil exposé aux agents atmosphériques (pluie, soleil, etc.);
- ne pas permettre l'utilisation de l'appareil de la part d'enfants ou de personnes non autorisées et n'ayant pas lu ni bien compris le contenu de cette notice.

 Le technicien autorisé doit, avant toute opération d'entretien, éteindre l'interrupteur de la machine et débrancher la fiche ou ouvrir le sectionneur.

 Pour les opérations de nettoyage, ne suivre que les instructions contenues dans cette notice.

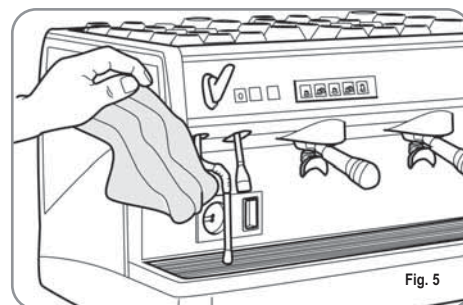

 En cas de panne ou de mauvais fonctionnement de l'appareil, éteignez-le. Il est strictement d'intervenir. Adressez-vous uniquement au personnel qualifié. La réparation éventuelle des produits ne devra être effectuée que par la Maison Constructrice ou par un centre de service après vente dûment autorisé, en utilisant uniquement des pièces détachées originales. L'inobservance de ces indications pourrait compromettre la sécurité de l'appareil.

Lors de l'installation, l'électricien autorisé devra prévoir un disjoncteur omnipolaire conforme aux normes en vigueur qui prévoient que les contacts aient un espace d'ouverture égal ou supérieur à 3 mm.

Afin d'éviter des surchauffes dangereuses, il est conseillé de bien dérouler sur toute la longueur le câble d'alimentation.

Ne pas obstruer les grilles d'aspiration et/ou de dissipation et plus particulièrement celles du chauffe-tasses.

La câble d'alimentation de cet appareil ne doit pas être remplacé par l'utilisateur. En cas d'endommagement du câble, éteindre l'appareil et le faire remplacer uniquement par un technicien qualifié.

Les appareils monophasés avec un courant supérieur à 15A et les appareils triphasés vendus sans fiche sont directement reliés à l'installation d'alimentation électrique à travers le câble; il n'est donc pas possible d'utiliser une fiche.

Si vous décidez de ne plus utiliser cet appareil, il est vivement conseillé de le rendre inefficace en coupant le câble d'alimentation, après avoir débranché le câble du réseau d'alimentation électrique.

ATTENTION
RISQUE DE POLLUTION

Ne jamais abandonner l'appareil dans l'environnement: pour son élimination totale, s'adresser à un centre autorisé ou contacter le fabricant afin de recevoir les instructions à ce sujet.

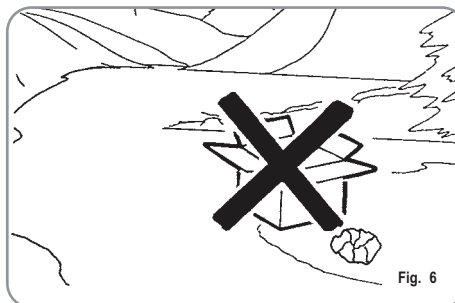

Fig. 6

ATTENTION
RISQUE D'INTOXICATION

Lors de l'utilisation du bec à vapeur, ne jamais exposer les mains à la vapeur. Ne jamais toucher le bec tout de suite après son utilisation.

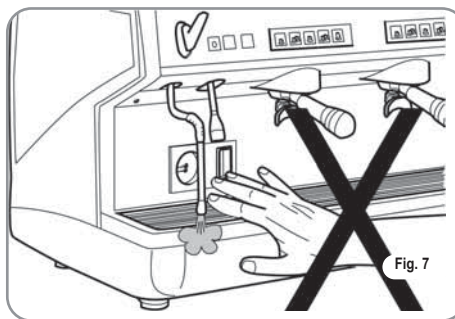

Fig. 7

ATTENTION
RISQUE DE BRULURES

Pour effectuer toute opération relative à l'installation, l'entretien, le déchargement et la mise au point, l'opérateur qualifié devra toujours porter ses gants de travail et ses chaussures de protection.

Le niveau maximum de pollution sonore émise est inférieur à 70db.

En cas de substitution du tube pour le branchement hydrique, le vieux tube ne doit plus être réutilisé.

ATTENTION

RENSEIGNEMENT AUX UTILISATEURS

Aux sens de l'art. 13 du Décret Législatif du 25 juillet 2005, n. 151 "Réalisation des Directives 2002/95/CE, 2002/96/CE et 2003/108/CE, relatives à la réduction de l'utilisation de substances dangereuses dans les appareils électriques et électroniques, ainsi qu'à l'enlèvement des ordures".

Le symbole de la poubelle barrée reporté sur l'appareillage indique que le produit, à la fin de sa propre vie utile, doit être recueilli séparément d'autres ordures. L'utilisateur devra, donc, transmettre l'appareillage arrivé à la fin de sa vie aux centres aptes à la récolte différenciée des déchets électroniques et électrotechniques, ou le rendre au détaillant au moment de l'achat d'un nouvel appareillage de même type, à raison d'échange un à un. La récolte différenciée propre pour le départ successif de l'appareillage laissé au recyclage, au traitement et à l'enlèvement compatible d'un point de vue de l'environnement, contribue à éviter de possibles effets négatifs sur le milieu et sur la santé et il favorise le recyclage des matériels dont l'appareillage se compose. L'enlèvement illégal du produit de la part de l'utilisateur comporte l'application des sanctions administratives dont au D.Lgs.n. 22/1997" (article 50 et suivants du D.Lgs.n.22/1997).

3. TRANSPORT ET DEPLACEMENT

3.1 IDENTIFICATION DE LA MACHINE

Pour toute communication avec le fabricant Nuova Simonelli, indiquer toujours le numéro de série qui est celui figurant dans ce manuel.



3.2 TRANSPORT

La machine est transportée sur des palettes avec d'autres machines et à l'intérieur de cartons; le tout étant fixé aux palettes au moyen des courroies appropriées.

Avant de procéder à toute opération de transport ou de déplacement, l'opérateur doit:

- mettre des gants et des chaussures de protection ainsi qu'une salopette munie d'élastiques aux extrémités.

Le transport des palettes doit être effectué au moyen d'un appareil de soulèvement approprié (du type chariot élévateur à fourches).

3.3 DEPLACEMENT



ATTENTION

RISQUE D'IMPACT OU D'ECRASEMENT

Lors des opérations de déplacement, l'opérateur doit s'assurer qu'aucune personne, chose ou objet ne se trouve dans la zone d'opération.

Soulever doucement la palette à 30 cm environ de terre et rejoindre la zone de chargement.

Une FIS atteinte la zone de chargement et après avoir vérifié l'absence d'obstacles, de choses ou de personnes, poser la palette à terre toujours au moyen d'un appareil de levage approprié (par exemple, un chariot élévateur à fourches), puis la déplacer en la soulevant à 30 cm environ de terre jusqu'à la zone de stockage.



ATTENTION

RISQUE D'IMPACT OU D'ECRASEMENT

Avant de procéder à l'opération décrite ci-après, s'assurer que le matériel chargé soit bien positionné et qu'il ne tombe pas après la coupure des courroies.

Pour couper les courroies et stocker le produit, l'opérateur doit toujours être muni de gants et de chaussures de protection; pour effectuer cette opération, consulter les caractéristiques techniques du produit afin de contrôler le poids de la machine devant être emmagasinée et de pouvoir agir en conséquence.

4. INSTALLATION ET OPERATIONS PRELIMINAIRES

Après avoir retiré l'emballage et avoir vérifié l'intégrité de la machine et de ses accessoires, procéder de la façon suivante:

- Positionner la machine sur un plan horizontal;
- Assembler les pieds de support de la machine en introduisant la broche dans la coquille cylindrique;
- Visser le pied en caoutchouc dans le filetage de la broche contenue dans la coquille;
- Visser l'ensemble du groupe assemblé dans les emplacements des pieds de la machine;
- Nivelier la machine en agissant sur les pieds de réglage;

NOTE: la rainure de la coquille doit être dirigée vers le haut, comme indiqué dans la figure suivante.

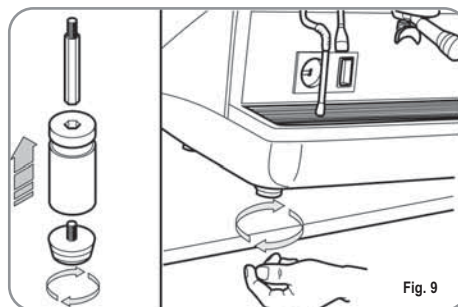

Dans la phase préliminaire, après la mise en plan de la machine, il est conseillé d'installer un adoucisseur (1), à la sortie du circuit hydrique, puis un filtre à maille (2).

Cela empêche les impuretés, telles que le sable, les particules de calcaire en suspension, la rouille, etc., d'endommager les surfaces délicates en graphite, garantissant une longue durée de vie de la machine.

Après ces opérations, procéder aux branchements hydrauliques comme illustré dans la figure suivante.



ATTENTION

La pression du réseau hydrique conseillé est de 2,3 bars.



ATTENTION

Eviter les étranglements des tubes de connexion. Vérifier en outre que l'évacuation (3) soit en mesure d'éliminer les rebuts.

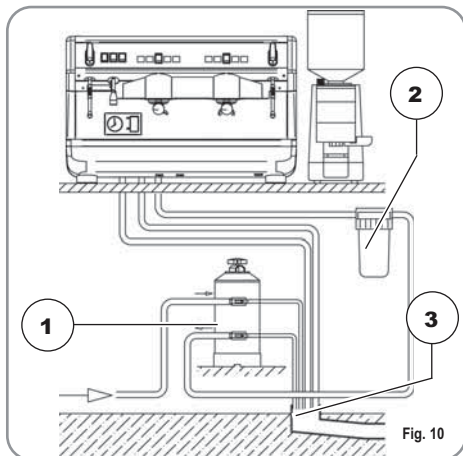

LEGENDA

- 1 Adoucisseur
- 2 Filtre à maille
- 3 Evacuation Ø 50 mm

NOTE: Pour le bon fonctionnement de la machine, il est nécessaire que la pression du réseau ne dépasse pas les 4 bar. Dans le cas contraire, installer un réducteur de pression en amont de l'adoucisseur; le tube en entrée de l'eau doit avoir un diamètre interne non inférieur à 6 mm ($\frac{3}{8}$ ”).



**ATTENTION
RISQUE DE DECHARGE ELECTRIQUE**

La machine doit toujours être protégée par un interrupteur automatique omnipolaire de puissance appropriée, avec une distance d'ouverture des contacts égale ou supérieure à 3 mm. Nuova Simonelli ne répond d'aucun dommage aux personnes ou aux choses dérivant du non respect des normes de sécurité en vigueur.

Avant de brancher la machine à un réseau électrique, vérifiez que le voltage indiqué sur la plaque des données de la machine correspond à celle de votre réseau.

Dans le cas contraire, effectuez les branchements ci-dessous sur la base de la ligne électrique dont vous disposez, comme illustré ci-après:

- pour un voltage **V 380 / 3 phases + Neutre:**

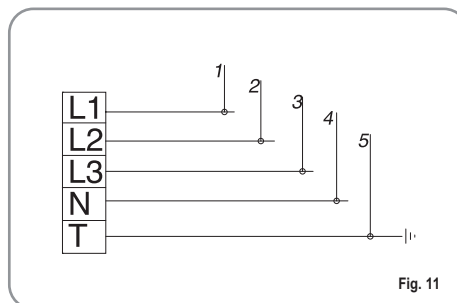

- pour un voltage **V 230 / monophasé**

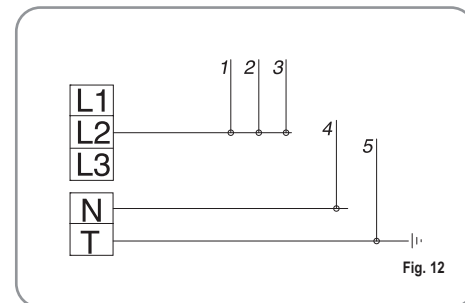

LEGENDA

- | | |
|----------|--------------|
| 1 Noir | 4 Bleu |
| 2 Gris | 5 Jaune vert |
| 3 Marron | |

NOTE: En début de journée et en cas de pauses dépassant les 8 heures, il est nécessaire de procéder à la vidange complète de l'eau (100%) contenue dans les circuits, à travers les distributeurs respectifs.

NOTE: Pour les exercices où le service est continu, effectuer les vidanges susmentionnées au moins une fois par semaine.

5. REGLAGES DU TECHNICIEN QUALIFIE



ATTENTION

Les réglages énumérés ci-dessous doivent être effectués **UNIQUEMENT** par un Technicien Spécialisé.

Nuova Simonelli ne répond d'aucun dommage aux personnes ou aux choses, dérivant du non respect des prescriptions de sécurité décrites dans ce manuel.



**ATTENTION
DANGER DE SECOUSSE
ELECTRIQUE**

Le technicien spécialisé doit, avant d'effectuer toute opération de réglage, éteindre l'interrupteur de la machine et débrancher la fiche.

5.1 **REPLISSAGE MANUEL DE LA CHAUDIERE**

Tous les modèles *Appia* sont munis d'une sonde de niveau, afin de maintenir le niveau de l'eau stable à l'intérieur de la chaudière.

Il est de règle, lors de la première mise en marche de la machine, de remplir manuellement la chaudière afin d'éviter que la résistance électrique ne s'abîme et n'enclenche la protection électronique.

Si cela devait arriver, il suffit d'éteindre la machine et de la rallumer pour achever le chargement (voir chapitre "MESSAGES FONCTIONS MACHINE – ERREUR NIVEAU").

Pour effectuer le premier remplissage manuel, agir de la façon suivante:

- enlever la grille du plan de travail;

- agir sur le robinet niveau manuel "A", pour permettre l'entrée de l'eau dans la chaudière;
- une fois le niveau minimum atteint, indiqué par le niveau optique, refermer le robinet "A"

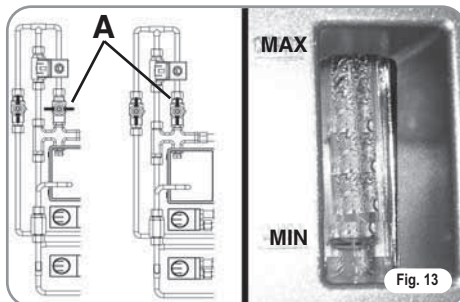

- allumer la machine, en positionnant l'interrupteur général sur "I", de façon à actionner la sonde de niveau qui se chargera de maintenir de façon automatique le niveau de l'eau à l'intérieur de la chaudière.

5.2 **REGLAGE PRESSOSTAT / POMPE**

Pour modifier la pression de service de la chaudière, c'est-à-dire la température de l'eau, en fonction des différentes exigences ou des caractéristiques du café utilisé, agir de la façon suivante:

- enlever la grille du plan de travail;
- retirer la tôle de protection en dévissant les deux vis latérales (A) comme illustré dans la figure suivante;



- agir sur la vis de réglage de la pompe pour AUGMENTER (vers la droite) ou DIMINUER (vers la gauche) LA PRESSION;

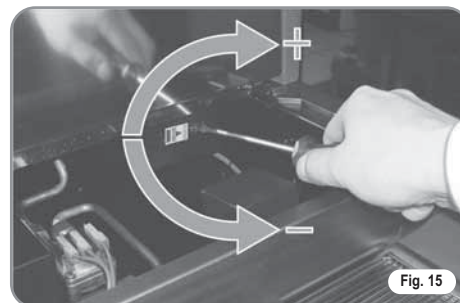

Valeur conseillée: 1 - 1,4 bar
(selon le type de café).

- Agir sur la vis de réglage de la pompe pour AUGMENTE (vers la droite) ou pour DIMINUER (vers la gauche) la pression;

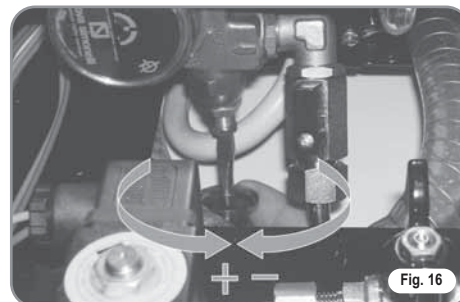

Valeur conseillée: 9 bar.

- La pression programmée de la pompe est affichée dans la partie inférieure du manomètre.

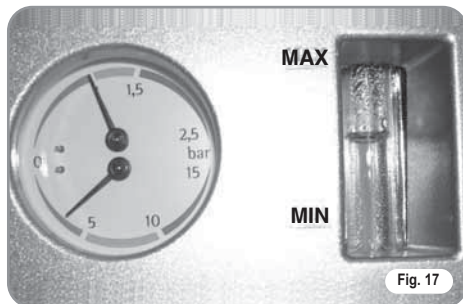

A la fin des opérations de réglage, repositionner la tôle de protection à sa place en la fixant avec les quatre vis latérales; repositionner la grille du plan de travail.

5.3 REGLAGE ECONOMISEUR EAU CHAUDE (option sur la version V/ESSE)

Tous les modèles *Appia* sont équipés d'un mélangeur d'eau chaude, qui permet de régler la température de sortie et d'optimiser le rendement du système.

Pour régler l'économiseur d'eau chaude, il faut retirer le panneau de gauche de la machine, et procéder comme décrit ci-dessous :

- dévisser les deux vis supérieures (Fig. 18);



- dévisser la vis situé sur le côté de la lance à vapeur A;
- frapper le poussoir B et retirer le panneau de gauche.

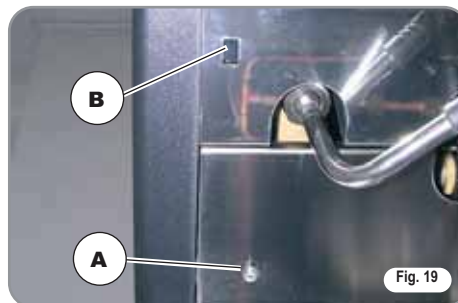

- pour régler la température de l'eau chaude en sortie de la lance, tourner la poignée de réglage vers la DROITE / GAUCHE pour AUGMENTER / DIMINUER la température;



- au terme de l'opération, remonter le panneau de gauche de la machine.

5.4 REMPLACEMENT DES TABLEAUX A POUSSOIRS

Pour un fonctionnement correct il est nécessaire, au moment du remplacement, de personnaliser chaque carte du tableau à poussoirs en agissant sur les sélecteurs situés sur la carte (du côté des touches), comme indiqué ci-dessous.

GROUPE	sw1	sw2	sw3	sw4	sw5	sw6
Groupe 1	On	Off	Off	On	Off	Off
Groupe 2	Off	On	Off	Off	On	Off
Groupe 3	Off	Off	On	Off	Off	On

6. UTILISATION

Avant de commencer à travailler, l'opérateur doit avoir lu et compris toutes les prescriptions de sécurité indiquées dans ce manuel.

6.1 APPIA V

6.1.1 MISE EN MARCHÉ

- Brancher la machine à la prise électrique.
- Positionner l'interrupteur général (n°13, Fig. 1) sur "ON".

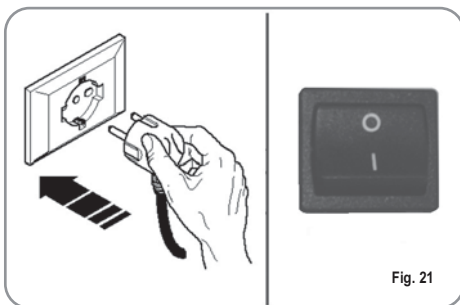





Fig. 21

Le témoin de la touche de mise en marche  commence à clignoter.

Appuyer sur la touche de mise en marche  pendant 5 secondes;

Le Lamp-test démarre et tous les témoins sont allumés; après 3 secondes, le Lamp-test termine et la touche eau chaude  s'éteint.

L'état de machine en fonction est indiqué par l'allumage permanent du témoin de la touche de mise en marche  ainsi que de tous les témoins des touches de distribution.



NOTE: toutes les touches de sélection sont validées dès la fin du diagnostic.



ATTENTION

En cas d'entretien de la fiche électronique, éteindre la machine à travers l'interrupteur général externe ou débrancher le câble d'alimentation.

6.1.2 ARRÊT

- En appuyant sur la touche de mise en marche / arrêt  pendant environ 2 secondes, la machine s'éteint et le témoin de la touche de mise en marche / arrêt  se remet à clignoter.
- Positionner alors l'interrupteur général sur "OFF".

6.2 APPIA ESSE

6.2.1 MISE EN MARCHÉ

- Brancher la machine à la prise électrique et positionner l'interrupteur général (n°13 fig. 1) sur "ON".

6.2.2 ARRÊT

- Positionner l'interrupteur général (n°13, Fig.1) sur "OFF".

6.3 CONFIGURATION SELECTION

Programmer la fonction désirée sur les touches à disposition situées sur les supports à filtres (Voir chapitre "DESCRIPTION").



Fig. 22

LEGENDE TOUCHES (Configuration sélections)



1 Café serré



2 Café serré



1 Café léger



2 Café léger



Continu

6.4 PREPARATION DU CAFE

Dégager le support à filtre et remplir l'une ou les deux doses de café moulu selon le filtre utilisé.

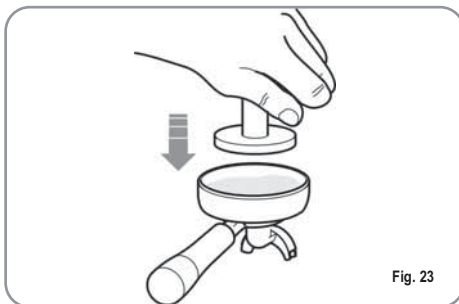

Fig. 23

Presser le café avec le presseur fourni en dotation, nettoyer le bord annulaire du filtre des résidus de poudre de café (pour garantir une meilleure tenue et une moindre usure de la garniture du filtre).

Emboîter alors le support à filtre sur le groupe. Frapper le pousoir café désiré:



1 Café serré



2 Café serré



1 Café léger



2 Café léger

La pompe s'actionne et l'électrovanne du groupe s'ouvre, en faisant démarrer l'infusion du café.

L'opération est indiquée par l'allumage de la touche frappée.

NOTE: lors des pauses, laisser le support à filtre emboîté afin qu'il reste chaud. Les groupes de distribution sont com-

pensés thermiquement par circulation totale d'eau chaude, afin de garantir le maximum de stabilité thermique pendant le service

6.5 UTILISATION DE LA VAPEUR



**ATTENTION
RISQUE DE BRULURES**

Pendant l'utilisation de la vapeur, veiller à ne pas mettre les mains sous la vapeur et à ne pas toucher tout de suite la lance.

Pour utiliser la vapeur, il suffit de tirer ou de pousser le levier correspondant (Fig. 24).

En tirant entièrement le levier, ce dernier reste bloqué en position de distribution maximum, en le poussant, son retour est automatique.

Les deux lances à vapeur sont articulées, permettant une utilisation plus aisée.



Fig. 24

NOTE: L'utilisation de la lance vapeur doit être précédée d'une purge d'au moins 2 secondes de l'eau de condensation ou selon les instructions du constructeur.

6.6 PREPARATION DU CAPPUCCINO

our obtenir la mousse typique du cappuccino,

plonger le bec de la vapeur au fond du récipient qui doit être rempli d'un tiers (il est préférable que le récipient soit conique et allongé).

Ouvrir la vapeur. Avant que le lait n'ait atteint l'ébullition, positionner le bec de la vapeur à la surface en effleurant le lait par des petits mouvements dans le sens vertical. A la fin de l'opération, nettoyer soigneusement la lance avec un chiffon souple.

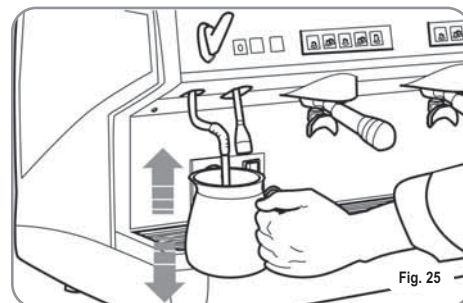

Fig. 25

6.7 SELECTION EAU CHAUDE



**ATTENTION
RISQUE DE BRULURES**

Pendant l'utilisation de la lance à eau chaude, veiller à ne pas mettre les mains sous la vapeur et à ne pas toucher tout de suite la lance.

Permet la distribution de l'eau chaude pour la préparation du thé, de la camomille et des tisane.

Positionner un récipient sous la lance de l'eau chaude et actionner l'interrupteur (version ESSE) ou frapper le pousoir de sélection eau chaude  (version V).

Vérifier que le pousoir s'allume.

La lance à eau chaude distribue de l'eau pendant le temps programmé.

NOTE: La distribution de l'eau chaude peut se faire en même temps que celle du café.

7. PROGRAMMATION Appia V

7.1 PROGRAMMATION DOSES

Pour accéder aux pages de programmation, procéder de la façon suivante:

NOTE: Cette opération peut être effectuée avec la machine allumée.

- Pour entrer dans la page de programmation des doses de chaque groupe, il faut appuyer pendant 5 secondes sur la touche de distribution continue .

- Les touches de distribution se mettent à clignoter.
- L'accès à la programmation du premier groupe valide aussi la programmation des paramètres de fonctionnement de la machine.

7.2 PROGRAMMATION DOSES CAFE

Pour programmer la dose d'eau relative à l'une des touches de distribution, procéder comme suit:

- Remplir avec la juste dose de café le porte filtre (le porte filtre peut être simple ou double, selon la touche que l'on désire programmer).
- Enclencher le porte filtre sur le groupe.
- Frapper l'un des poussoirs distributeurs:



- La distribution commence ; lorsque la quantité désirée est atteinte, frapper la touche continue .

- La distribution s'arrête et la touche doses sélectionnée s'éteint (les autres touches continuent à clignoter).





- Frapper la touche continue  pour quitter la programmation ou pour continuer la programmation des autres touches doses.

NOTA: Cette procédure est valable pour tous les groupes de la machine; si elle est effectuée indépendamment pour chaque groupe (un groupe à la fois), les autres groupes peuvent continuer à fonctionner normalement.

7.3 PROGRAMMATION EAU CHAUDE

- Entrer dans la page de programmation selon la procédure relative.
- Frapper la touche sélection eau chaude .

- La distribution de l'eau chaude commence.
- Etablir la dose d'eau chaude désirée et frapper à nouveau la touche .





- Frapper la touche continue  pour quitter la programmation ou pour continuer la programmation des autres touches sélection.

7.4 PROGRAMMATION CHAUFFE-TASSES (option)

- Entrer dans la page de programmation du premier groupe selon la procédure relative.
- Frapper la touche de sélection chauffe-tasses .

- Les poussoirs de distribution du premier et du deuxième groupe signalent respectivement le temps de mise en marche et d'arrêt en modalité automatique, alors que les touches continues  du premier et du deuxième groupe clignotent.

Comme indiqué dans le tableau, chaque touche de distribution est associée à une valeur; le temps de mise en marche du chauffe-tasses est obtenu par la somme des valeurs des touches du premier groupe allumées. La même modalité de calcul est valable pour le temps d'arrêt du chauffe-tasses du deuxième groupe.

Touche	Groupe 1 (temps on)	Groupe 2 (temps off)
	2 min.	5 min.
	4 min.	10 min.
	8 min.	20 min.
	16 min.	40 min.

7.5 PROGRAMMATION DOSES STANDARD

- Il est possible de programmer des valeurs prédéterminées pour les 4 doses du groupe, pour l'eau (vapeur).

Pour cela, il suffit d'appuyer sur la touche  pendant au moins 10 secondes jusqu'à ce que les touches clignotantes s'éteignent.

Les doses sont:

1CN	2CN	1CL	2CL
40 cc	60 cc	50 cc	85 cc

EAU
9 sec.

NOTE: Un temps de 0 secondes pour l'eau et pour la vapeur ne détermine pas le fonctionnement en modalité continue.

7.6 COPIAGE DOSES

Il est possible de copier les doses mémorisées pour le groupe 1 dans les doses du groupe 2 ou 3.



Cette opération est possible en appuyant sur la touche continue  du groupe 2 ou 3 pendant

au moins 8 secondes jusqu'à ce que les touches clignotantes s'éteignent.

7.7 PROGRAMMATION PARAMETRES DE FONCTIONNEMENT





Les réglages énumérés ci-dessous doivent être effectués UNIQUEMENT par un Technicien Spécialisé.

En appuyant sur la touche  du deuxième groupe, après avoir accédé à la page de programmation du premier groupe, on accède à la programmation des paramètres de fonctionnement de la machine; situation indiquée par l'allumage de la touche continue du deuxième groupe .

1. Activation pompe si niveau activé.
2. Activation bloc logiciel pour accès à programmation doses.
3. Réglage luminosité clavier.
4. Activation pompe avec eau chaude (sur les machines avec économiseur).
5. Exclusion du chauffe-tasses.
6. Rétablissement paramètres de défaut.

1. Activation pompe pendant le niveau.

A l'aide de la touche café serré  du deuxième groupe, on programme l'activation de la pompe pendant le niveau:

si la touche  est allumée, la pompe s'actionne avec le niveau, alors que si la touche est éteinte, la pompe ne s'actionne pas avec le niveau.

2. Activation bloc logiciel pour accès à programmation doses.

A l'aide de la touche café léger  on actionne le bloc logiciel pour la programmation des doses (touche allumée) ou on exclut le bloc (touche éteinte).

3. Réglage luminosité clavier.

La touche 2 cafés légers  du deuxième groupe est utilisée pour choisir la luminosité des touches parmi 5 degrés pré-établis.

En frappant la touche , qui clignote, on change le degré de luminosité, en baissant la valeur jusqu'au minimum pour retourner ensuite à la valeur maximum.

4. Activation pompe avec eau chaude (uniquement sur les machines avec économiseur).

A l'aide de la touche eau chaude , on programme l'activation de la pompe pendant la distribution de l'eau.

Si la touche  est allumée, la pompe s'actionne pendant la distribution d'eau chaude, alors que si la touche est éteinte, la pompe ne s'actionne pas.

5. Exclusion du chauffe-tasses.

A l'aide de la touche , on actionne ou on exclut le fonctionnement du chauffe-tasses; si la touche est allumée, le chauffe-tasses fonctionne normalement comme établi dans la programmation; si la touche est éteinte, le chauffe-tasses est exclu.

Si le chauffe-tasses est exclu, la touche  s'allume uniquement pendant le

Lamp-test, après quoi toute pression sur la touche ne produit aucun effet.

En frappant la touche continue  du deuxième groupe, les valeurs modifiées sont mémorisées et on quitte la page de programmation des paramètres de fonctionnement de la machine.

6. Rétablissement paramètres de défaut

Un rétablissement des paramètres de défaut est possible, à savoir les paramètres de niveau pompe, eaux avec pompe, lumière maximum et chauffe-tasses validé.

Pour rétablir ces paramètres, il suffit d'allumer la machine, à l'aide de la touche , avec



les touches 2 cafés serrés  et 2 cafés

légers  du premier groupe appuyés en même temps.

7.8 CYCLE AUTOMATIQUE DE NETTOYAGE DES GROUPES

Pour accéder à la page de nettoyage automatique, il faut éteindre la machine puis la rallumer en appuyant sur les touches eau chaude

 et chauffe-tasses  pendant toute la durée du Lamp-test initial.



Au terme du Lamp-test, les touches  et  commencent à clignoter ainsi que les



touches 1 café léger  de tous les groupes.

En frappant la touche , le cycle de lavage du groupe correspondant démarre.

Une fois le cycle de lavage terminé, il est possible d'effectuer un cycle de rinçage sur le même groupe, en frappant à nouveau la touche





Si on désire effectuer le cycle de lavage dans un deuxième temps, il suffit d'éteindre la machine: la fiche maintient en mémoire les cycles de nettoyage à terminer. Lors de la mise en marche successive de la machine, la fiche se positionne automatiquement sur la modalité de nettoyage des groupes, sans devoir frapper les touches  et .

En appuyant sur les touches  et  pendant 2 secondes, on quitte la moda

lité de nettoyage s'il n'y a pas de cycles de rinçage à terminer, autrement les touches  continuent à clignoter pour les

groupes qui n'ont pas achever leur cycle de rinçage.

En appuyant sur les touches  et  pendant 2 autres secondes, on force la

sortie de la modalité de nettoyage en zéro tant l'information sur les rinçages à terminer.

Si le cycle de nettoyage est complété, la touche  du groupe s'éteint.

S'il n'y a pas d'autres cycles de rinçage à effectuer, la fiche quitte la modalité de nettoyage.

8. NETTOYAGE ET ENTRETIEN

Durant l'entretien/réparation, les composants utilisés doivent garantir le maintien des conditions d'hygiène et de sécurité prévues pour le dispositif. Les pièces de rechange originales fournissent cette garantie.

Après une réparation ou une substitution de composants qui concernent des parties qui sont en contact avec l'eau et les aliments, il faut effectuer la procédure de lavage ou suivre les procédures indiquées par le constructeur.

8.1 ARRET

Pour arrêter la machine, il faut appuyer à nouveau sur l'interrupteur général et le positionner sur OFF.

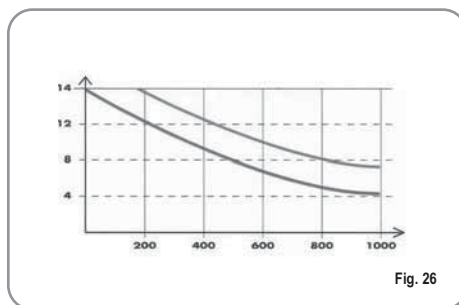

8.2 NETTOYAGE DE LA CARROSSERIE

Avant toute opération de nettoyage, il faut placer la machine à l'état énergétique "O" (c'est-à-dire interrupteur machine éteint et sectionneur ouvert).



Il n'est pas possible de nettoyer l'appareil avec un jet d'eau ou en le plongeant dans l'eau.



ATTENTION

Ne pas utiliser de solvants, de produits à base de chlore, ni d'abrasifs.

Nettoyage de la zone de travail: extraire la grille du plan de travail en la soulevant vers le haut et en la faisant glisser; retirer le plateau de récupération de l'eau et nettoyer le tout avec de l'eau chaude et du détergent. **Nettoyage carrosserie:** pour nettoyer toutes les parties chromées, utiliser un chiffon humide.

8.3 NETTOYAGE DES DOUCHES INOX

Les douches inox sont situées sous les groupes de distribution, comme illustré en Fig. 27.



NOTE: Pour le nettoyage, procéder de la façon suivante:

- Dévisser la vis située au centre de la douche.
- Extraire la douche en la désenfilant et vérifier que les trous ne soient pas bouchés.
- En cas d'obstruction, nettoyer selon les indications du paragraphe "NETTOYAGE DES FILTRES ET DES SUPPORTS A FILTRES".

Il est recommandé d'effectuer le nettoyage des douches toutes les semaines.

8.4 NETTOYAGE DU GROUPE AVEC L'AIDE DU FILTRE BORGNE

La machine est prédisposée pour le nettoyage du groupe de distribution à l'aide d'un produit détergent spécifique en poudre.

Il est conseillé d'effectuer le lavage au moins une fois par jour en utilisant les produits détergents adéquats.



ATTENTION RISQUE D'INTOXICATION

Une fois que le support à filtre a été retiré, effectuer quelques distributions pour éliminer les éventuels résidus de détergent.

Pour exécuter la procédure de lavage, procéder de la façon suivante:

- 1) Remplacer le filtre avec le filtre borgne du groupe de distribution.
- 2) Le remplir avec deux cuillères de détergent spécial en poudre et emboîter le support à filtre sur le groupe.
- 3) Frapper l'une des touches café et interrompre après 10 secondes.
- 4) Répéter l'opération plusieurs fois.
- 5) Retirer le support à filtre et effectuer quelques distributions.

8.5 NETTOYAGE DES FILTRES ET DES SUPPORTS A FILTRES

Mettre deux cuillères de détergent spécial en poudre dans un demi litre d'eau chaude et y plonger le filtre et le support à filtre (sauf le manche) pendant une demie heure au moins. Rincer ensuite abondamment sous le robinet d'eau.

8.6 REVIVIFICATION DES RESINES DE L'ADOUCCISSEUR

Afin d'éviter la formation de dépôts calcaires à l'intérieur de la chaudière et des échangeurs de chaleur, il est nécessaire que l'adoucisseur soit toujours parfaitement efficace. Il faut pour cela effectuer régulièrement la revivification des résines ioniques.

Les temps de revivification doivent être établis en fonction du nombre de café distribués quotidiennement et de la dureté de l'eau utilisée. Ils peuvent être déduits, à titre indicatif, du diagramme reporté en Fig. 28.

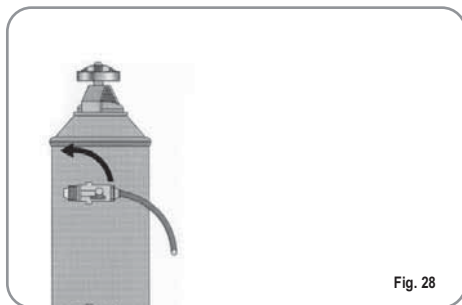

Les procédures de revivification sont les suivantes:

1) Eteindre la machine et placer un récipient d'une capacité d'au moins 5 litres sous le tube E (Fig. 29).

Tourner les leviers C et D de gauche à droite; retirer le bouchon en dévissant la poignée G et introduire 1 Kg de gros sel de cuisine (Fig. 30).

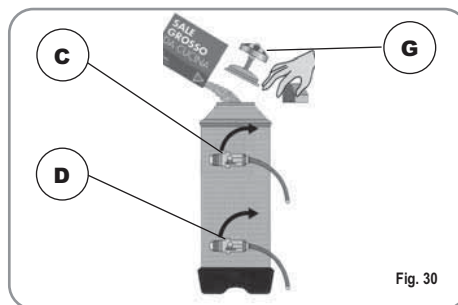
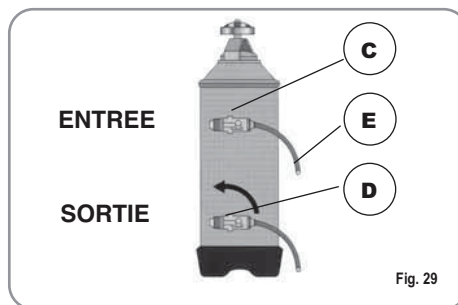

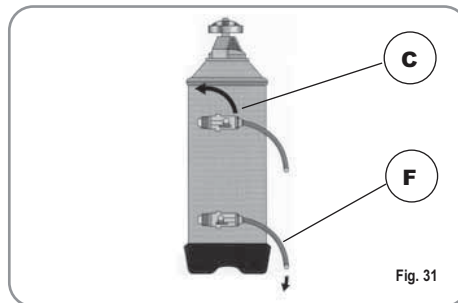

2) Remettre le bouchon et repositionner le levier C vers la gauche (Fig. 31), en faisant évacuer l'eau salée du tube F jusqu'à ce qu'elle soit à nouveau douce (1/2 heure environ).

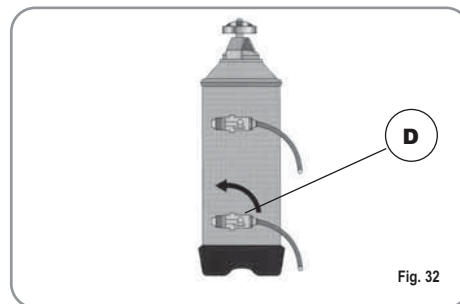

3) Repositionner alors le levier D vers la gauche (Fig. 32).



9. MESSAGES FONCTIONS MACHINE Appia V

INDICATIONS AFFICHAGE ET TOUCHES	CAUSES	EFFET	SOLUTION	NOTE
Dessin touche continue  cli- tante et touche distribution  fixe.	Si, dans les 3 premières secondes suivant le début de la distribution, le doseur n'a pas envoyé les impulsions programmées.	Si la distribution n'est pas interrompue manuellement, on obtient le blocage de temps limite (120 sec.).	Interrompre la distribution.	
Dessin touche continue clignotante. 	Lorsque, 90 secondes après le commencement, si la pompe est insérée lors de la mise à niveau haut, et après 180 secondes si elle est exclue, le niveau n'a pas été rétabli.	La pompe est désactivée et la résistance ainsi que toutes les fonctions sont exclues.	Eteindre la machine pendant au moins 5 secondes, puis la rallumer.	

NOTE:

Dotted lines for writing notes.

Sehr geehrte Kundin, sehr geehrter Kunde,

Sie haben sich für das Modell *Appia* entschieden und damit eine ausgezeichnete Wahl getroffen.

Beim Kauf einer Profi-Espressomaschine spielen viele Faktoren eine wichtige Rolle: der Name des Herstellers, die Maschinenfunktionen, die technische Zuverlässigkeit, ein schneller und angemessener Kundenservice, die Kosten. Sie haben dies alles sicherlich in Erwägung gezogen und sich anschließend für das Modell *Appia* entschieden.

Sie haben sich für das - unserer Meinung nach - beste Produkt entschieden, dessen Güte Sie mit jedem Espresso und Cappuccino testen können.

Appia ist bedienungsleicht, praktisch und effizient.

Falls Sie zum ersten Mal eine Maschine Nuova Simonelli kaufen, möchten wir Sie im Segment der Alta Caffetteria willkommen heißen. Wenn Sie schon zu unseren Kunden gehören, danken wir Ihnen für das Vertrauen, das Sie uns schenken!

Ein herzliches Dankeschön dafür, uns den Vorzug gegeben zu haben.

Mit freundlichen Grüßen.

Nuova Simonelli S.p.a.



Appia[®]
MADE IN ITALY

DEUTSCH

TECHNISCHE EIGENSCHAFTEN

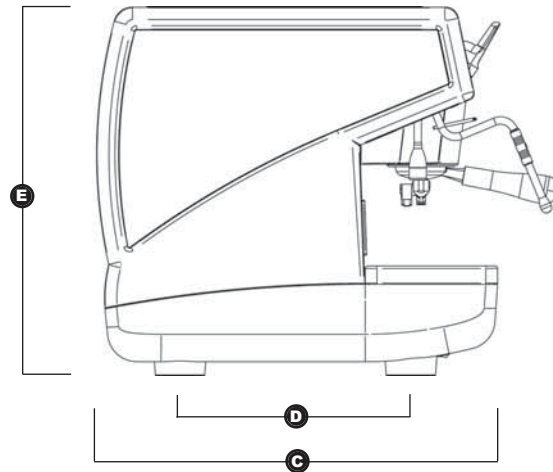
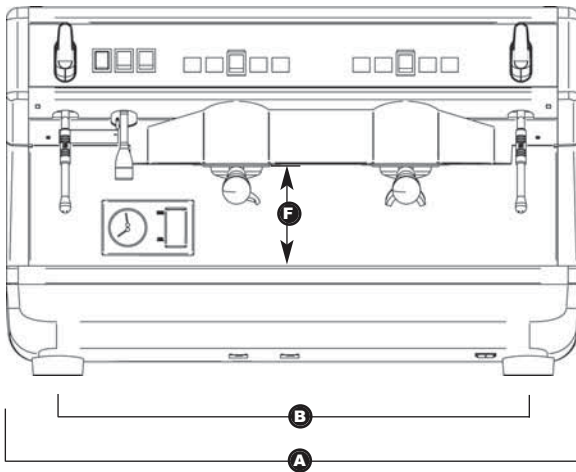

	2 Gruppen		3 Gruppen	
NETTOGEWICHT	60 kg	133 lb	74 kg	163 lb
BRUTTOGEWICHT	65 kg	143 lb	80 kg	176 lb
HEIZLEISTUNG	3000 W	3000 W	5000 W	5000 W
ABMESSUNGEN	A 785 mm	A 30 ⁷ / ₈ "	A 1010 mm	A 39 ⁷ / ₈ "
	B 690 mm	B 27 ¹ / ₈ "	B 920 mm	B 36 ³ / ₁₆ "
	C 545 mm	C 21 ⁷ / ₁₆ "	C 545 mm	C 21 ⁷ / ₁₆ "
	D 370 mm	D 14 ⁹ / ₁₆ "	D 370 mm	D 14 ⁹ / ₁₆ "
	E 530 mm	E 20 ¹ / ₄ "	E 530 mm	E 20 ¹ / ₄ "
	F 135 mm	F 5 ¹ / ₈ "	F 135 mm	F 5 ¹ / ₈ "

Appia[®]
MADE IN ITALY

INHALTSVERZEICHNIS

	TECHNISCHE EIGENSCHAFTEN	.24
1.	BESCHREIBUNG	.27
1.1	ZUBEHÖRLISTE	.28
2.	SICHERHEITSVORSCHRIFTEN	.29
3.	GERÄTETYP UND TRANSPORTBESTIMMUNGEN	.32
3.1	MASCHINENKENNZEICHNUNG	.32
3.2	TRANSPORT	.32
3.3	HANDHABUNG	.32
4.	INSTALLATION UND INBETRIEBNAHME	.33
5.	EINSTELLUNGEN DURCH DEN FACHMANN	.34
5.1	MANUELLES AUFFÜLLEN DES BOILERS	.34
5.2	REGELUNG DES PUMPENSCHALTERS	.34
5.3	REGELUNG DES HEISSWASSER-ECONOMISERS (optional Version V/ESSE)	.35
5.4	AUSWECHSLUNG DER DRUCKKNOPFTAFELN	.35
6.	GEBRAUCH DER MASCHINE	.36
6.1	APPIA V	.36
6.1.1	EINSCHALTUNG	.36
6.1.2	AUSSCHALTUNG	.36
6.2	APPIA ESSE	.36
6.2.1	EINSCHALTUNG	.36
6.2.2	AUSSCHALTUNG	.36
6.3	AUSWAHLARTEN	.36
6.4	ESPRESSOZUBEREITUNG	.37
6.5	DAMPFGEBRAUCH	.37
6.6	CAPPUCCINO-ZUBEREITUNG	.37
6.7	HEISSWASSERWÄHLER	.37
7.	PROGRAMMIERUNG APPIA V	.38
7.1	ZEICHENERKLÄRUNG	.38
7.2	PROGRAMMIERUNG DER KAFFEEDOSEN	.38
7.3	HEISSWASSERPROGRAMMIERUNG	.38
7.4	PROGRAMMIERUNG DES TASSENWÄRMERS (optional)	.38
7.5	PROGRAMMIERUNG DER STANDARDDOSEN	.39
7.6	DOSEN KOPIEREN	.39

7.7	PROGRAMMIERUNG DER BETRIEBSPARAMETER	.39
7.8	AUTOMATISCHER GRUPPENREINIGUNGSZYKLUS	40

8.	REINIGUNG UND PFLEGE	.41
8.1	STOPP	.41
8.2	GEHÄUSEREINIGUNG	.41
8.3	REINIGUNG DER EDELSTAHLBRAUSEN	.41
8.4	GRUPPENREINIGUNG MIT BLINDFILTER	.41
8.5	REINIGUNG DER FILTER UND SIEBTRÄGER	.41
8.6	ERNEUERUNG DER ENTHÄRTERHARZE	.42

9.	MELDUNGEN MASCHINENFUNKTIONEN APPIA V	.43
-----------	--	------------

ALEKTRISCHE ANLAGE APPIA ESSE 2/3 GRUPPEN	.68
--	------------

ALEKTRISCHE ANLAGE APPIA V 2 GRUPPEN	.70
---	------------

ALEKTRISCHE ANLAGE APPIA V 3 GRUPPEN	.72
---	------------

HYDRAULIKANLAGE	.74
------------------------	------------

DEUTSCH

Appia[®]
MADE IN ITALY

1. BESCHREIBUNG *Appia* V - Esse



Abb. 1

LEGENDE

- | | | | |
|---|---------------------|----|-------------------------|
| 1 | Auswahlkosten | 8 | Sichtanzeige |
| 2 | Ausgabekosten | 9 | Druckmesser |
| 3 | Dampfkopf | 10 | Verstellbarer Fuß |
| 4 | Dampfdüse | 11 | Heißwasserdüse |
| 5 | Filterhalter | 12 | Datenschild |
| 6 | Tülle für 1 Kaffee | 13 | Hauptschalter |
| 7 | Tülle für 2 Kaffees | 14 | Tassenwärmer (optional) |

1.1 ZUBEHÖRLISTE





Abb . 2

CODE	BESCHREIBUNG	2 GRUPPEN	3 GRUPPEN
A01	Rohr $\frac{3}{8}$ " voll	1	1
A02	Abflussrohr Ø 25 mm - l. 150 cm	1	1
A03	Siebträger	3	4
A04	Doppelsieb	2	3
A05	Einzelsieb	1	1
A06	Blindsieb	1	1
A07	Feder	3	4
A08	Doppelbrühdüse	2	3
A09	Einfachbrühdüse	1	1
A10	Espressostopfer	1	1

2. SICHERHEITSVORSCHRIFTEN

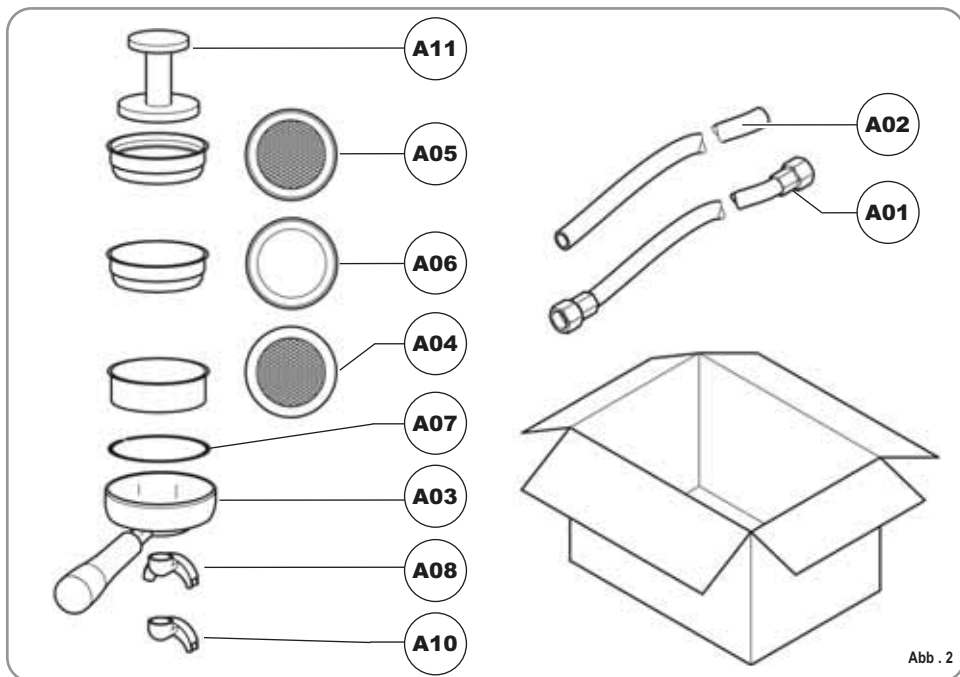
 Diese Bedienungsanleitung stellt einen wesentlichen Bestandteil des Erzeugnisses dar und ist dem Verbraucher auszuhändigen. Die in dieser Bedienungsanleitung enthaltenen Hinweise sind aufmerksam durchzulesen, weil sie wichtige Angaben hinsichtlich der Sicherheit für die Installation, der Bedienung und Wartung liefern. Diese Bedienungsanleitung ist sorgfältig für ein weiteres Zurateziehen aufzubewahren.

 Nachdem die Verpackung entfernt wurde, sind Sie von der Unversehrtheit des Gerätes zu überzeugen. Im Zweifelsfall das Gerät nicht benutzen und sich an Fachpersonal wenden. Das Verpackungsmaterial (Nylonsäcke, Polystyrolschaum, Nägel, usw.) nicht in der Reichweite von Kindern lassen, da diese eine große Gefahrenquelle darstellen, und ordnungsgemäß entsorgen.

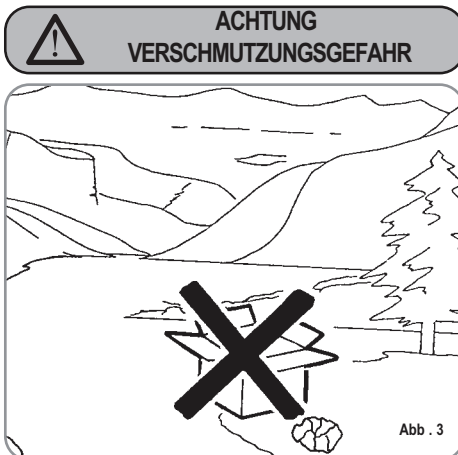



 Bevor das Gerät angeschlossen wird, vergewissern Sie sich, ob die auf dem Typenschild angegebenen Daten mit denen des elektrischen Versorgungsnetzes übereinstimmen. Das Typenschild befindet sich auf der Rückseite des Gerätes. Die Installation ist in Übereinstimmung mit den geltenden Vorschriften, gemäß den Anweisungen des Herstellers und durch Fachpersonal vorzunehmen. Für eventuelle Schäden, die durch eine nicht vorhandene Erdung der Stromversorgungsanlage hervorgerufen werden, kann der Hersteller nicht zur Verantwortung gezogen werden. Die elektrische Sicherheit dieses Gerätes wird nur dann erreicht, wenn ein ordnungsgemäß geerdeter Anschluß entsprechend den geltenden Sicherheitsvorschriften vorgenommen wird. Die Überprüfung dieser grundlegenden Anforderung auf Sicherheit ist unerlässlich und im Zweifelsfall wenden Sie sich zwecks sorgfältiger Kontrolle an Fachpersonal. Überprüfen Sie, ob die elektrische Leistung der Anlage für den auf dem Typenschild angegebenen Spitzenstrom geeignet ist und wenden Sie sich im Zweifelsfall an den Fachmann.



 Insbesondere ist von einem Fachmann festzustellen, ob der Kabelquerschnitt der Anlage für die Leistungsaufnahme des Gerätes geeignet ist. Zwischenstecker, Vielfachdosen und Verlängerungen dürfen nicht verwendet werden. Sollte sich dies jedoch nicht vermeiden lassen, muß ein autorisierter Elektriker zugezogen werden.

 Für die Geräte, die mit 220-230V gespeist werden, darf die vom Stromnetz gelieferte Impedanz von 0,37 Ohm nicht überschritten werden.

 Zur Installation des Gerätes sind die Bauteile und Materialien zu verwenden, die dem Gerät mitgeliefert werden. Sollte die Verwendung anderer Bauteile notwendig sein, so muss der Installationstechniker deren Eignung für die Verwendung im Kontakt mit Wasser prüfen, das für den menschlichen Verzehr bestimmt ist.

 Die Espressomaschine muß unter Beachtung der jeweils geltenden Vorschriften für die Wasserversorgung installiert werden. Wenden Sie sich bezüglich des Anschlusses an die Wasserleitung bitte an einen entsprechend ausgebildeten Flaschner.

 Das Gerät muss mit Wasser versorgt werden, das entsprechend den am Installationsort geltenden einschlägigen Bestimmungen für den menschlichen Verzehr geeignet ist. Der Installationstechniker muss beim Inhaber/ Betreiber der Anlage die Bestätigung einholen, dass das

Wasser die genannten Voraussetzungen erfüllt.

 Dieses Gerät ist nur für den ausdrücklich in diesem Handbuch beschriebenen Zweck zu verwenden. Der Hersteller kann nicht für Schäden, die durch unsachgemäßen und fehlerhaften Gebrauch hervorgerufen werden, verantwortlich gemacht werden.

 Das Gerät ist nicht geeignet für die Verwendung durch Kinder und Personen mit verringerten körperlichen, sensorischen oder geistigen Fähigkeiten bzw. Mangel an entsprechenden Kenntnissen, sofern sie nicht überwacht oder angeleitet werden.

 Die Höchst- und Mindesttemperaturen für die Lagerung müssen im Bereich [-5,+50]°C liegen.

 Nach erfolgter Installation wird das Gerät eingeschaltet, in den normalen Betriebszustand gebracht und im Zustand der "Betriebsbereitschaft" belassen. Danach wird das Gerät ausgeschaltet und das erste Füllwasser aus dem Wasserkreislauf abgelassen, um eventuelle anfängliche Unreinheiten zu beseitigen. Das Gerät wird dann neu gefüllt und in den normalen Betriebszustand gebracht.

Nach Erreichen der Betriebsbereitschaft ist wie folgt vorzugehen:

- 100%iges Leeren der Kaffeekreisläufe über den Ausgussschnabel (wenn mehrere Schnäbel vorhanden sind, die Menge gleichmäßig aufteilen);
- 100%iges Leeren des

Heißwasserkreislaufs über das Wasserrohr (wenn mehrere Rohre vorhanden sind, die Menge gleichmäßig aufteilen);

- Öffnen aller Dampfrohre für die Dauer einer Minute.

Nach erfolgter Installation sollte ein Bericht über die vorgenommenen Arbeiten erstellt werden.

 Die Betriebstemperatur muss zwischen +5 und +35°C liegen.

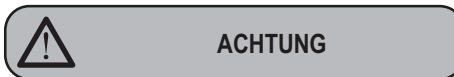

Bei Maschinen, die nicht mit Anschlusssteckern ausgestattet sind, muss das Stromnetz mit einem Trennschalter für jede einzelne Phase ausgestattet werden.

 Die Benutzung elektrischer Geräte bringt die Einhaltung einiger grundsätzlicher Regeln mit sich und zwar:

- das Gerät nicht mit feuchten Händen oder Füßen berühren;





- das Gerät nicht barfuß bedienen;
- in Badezimmern oder Duschen keine Verlängerungen verwenden;
- auf keinen Fall das Versorgungskabel ziehen, um den Netzanschluss zum Gerät zu unterbrechen;
- das Gerät nicht Witterungseinflüssen aussetzen (Regen, Sonne, usw.);
- darauf achten, dass das Gerät

nicht von Kindern oder Unbefugten benutzt wird und nicht von Personen, welche dieses Handbuch nicht gelesen und zur Kenntnis genommen haben.

 Der Fachtechniker muss vor der Ausführung von Wartungsarbeiten jeglicher Art den Hauptschalter der Maschine ausschalten und den Stecker aus der Steckdose ziehen, oder den Phasentrennschalter ausschalten.

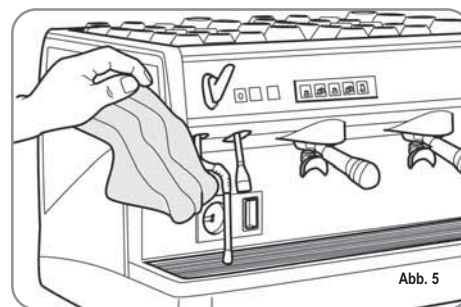
 Sich für die Reinigungsarbeiten ausschließlich an die in der Anleitung genannten Abläufe halten.



 Bei Defekt oder nicht einwandfreier Funktionsweise das Gerät ausschalten. Es ist strengstens verboten, einen Reparaturversuch oder direkten Eingriff vorzunehmen. Wenden Sie sich ausschließlich an Fachpersonal. Eine eventuelle Reparatur der Geräte ist nur von der Herstellerfirma oder von zugelassenen Kundendienstzentren unter Verwendung von Originalersatzteilen durchzuführen. Eine Nichtbeachtung der oben genannten Ausführungen kann die Sicherheit des Gerätes beeinträchtigen.

Bei der Installation ist, gemäß den geltenden Sicherheitsvorschriften, vom autorisierten Elektriker ein allpoliger Schalter mit einem Öffnungsabstand der Kontakte von mindestens 3 mm vorzusehen.

Zur Vermeidung von gefährlichen Erhitzungen wird geraten, das Versorgungskabel über seine gesamte Länge abzurollen.

Die Einlass- und/oder die Dissipationsgitter, vor allem beim Tassenwärmer, nicht verstopfen.

Das Versorgungskabel dieser Geräte darf nicht vom Benutzer ausgewechselt werden. Bei Beschädigung des Kabel, das Gerät ausschalten und sich für den Kabelwechsel ausschließlich an Fachpersonal wenden.

Die Einphasengeräte mit einem Strom von über 15A und die Dreiphasengeräte, die ohne Stecker verkauft wurden, werden direkt über das Kabel an die Stromversorgung angeschlossen; deshalb ist die Verwendung eines Steckers nicht möglich.

Falls die Entscheidung getroffen wird, ein solches Gerät nicht mehr zu benutzen, ist es wichtig dieses unbrauchbar zu machen indem man zuerst den Netzstecker herauszieht und dann das Versorgungskabel entfernt.

ACHTUNG
VERSCHMUTZUNGSGEFAHR

Nicht die Maschine in der Umwelt entsorgen: Für die Entsorgung der Maschine nach Außerbetriebsetzung wenden Sie sich an autorisierte Entsorgungsagenturen oder direkt an den Hersteller, der Ihnen entsprechende Hinweise geben wird.



Abb. 6

ACHTUNG
UMWELTGEFAHR

Bei Benutzung der Dampfduse ist Vorsicht geboten und darauf zu achten, dass die Hände keinesfalls unter den Dampfstrahl geraten. Ebenso die Düse nicht unmittelbar nach dem Gebrauch berühren.

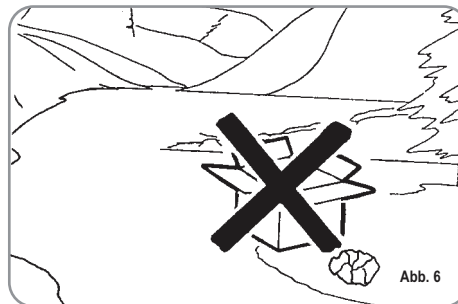

Abb. 7

ACHTUNG
VERBRÜHUNGSGEFAHR

Wir weisen darauf hin, dass die Fachkraft bei der Durchführung von Installations-, Wartungs-, Ablade- oder Regulierungsarbeiten Arbeitshandschuhe und Sicherheitsschuhe tragen muss.

Der maximale Geräuschpegel liegt unter 70db.

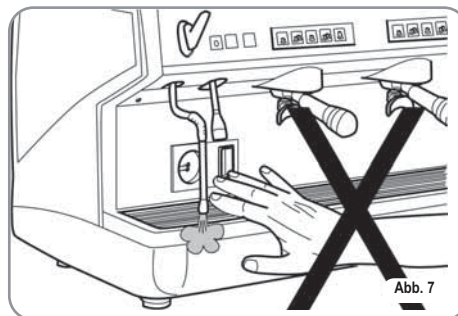
Wenn das Wasseranschlussrohr ausgetauscht wird, darf es nicht weiter verwendet werden.

ACHTUNG

INFORMATION AN BENUTZER

Im Sinne von Art. 13 der gesetzesvertretenden Rechtsverordnung Nr. 151 vom 25. Juli 2005, „Durchführung der Richtlinien 2002/95/EG, 2002/96/EG und 2003/108/EG über die Verringerung der Verwendung von gefährlichen Stoffen in elektrischen und elektronischen Geräten sowie über Abfallentsorgung“.

Das Symbol „durchgestrichene Mülltonne“ auf dem Gerät bedeutet, dass das Produkt am Ende seiner Lebensdauer getrennt gesammelt werden muss. Der Benutzer muss daher das Gerät am Ende seiner Lebensdauer in den zugelassenen Sammelstellen für getrennte Abfallsammlung von elektronischen und elektrotechnischen Abfällen beseitigen oder es dem Verkäufer zurückgeben, falls er ein ähnliches Gerät kauft, so dass ein Verhältnis 1 zu 1 entsteht. Die angemessene getrennte Abfallsammlung vor der Lieferung des alten Gerätes zu umweltfreundlichen Recycling-, Behandlungs- und Entsorgungsanlagen trägt dazu bei, eventuelle schädliche Auswirkungen auf die Umwelt und Gesundheit zu vermeiden und unterstützt das Recycling von Stoffen, die das Gerät beinhaltet. Die unzulässige Entsorgung des Produktes hat die Verhängung einer Strafe im Sinne der gesetzesvertretenden Rechtsverordnung Nr. 22/1997 (Artikel 50 ff. der gesetzesvertretenden Rechtsverordnung Nr. 22/1997) zur Folge.

DEUTSCH

3. GERÄTETYP UND TRANSPORTBESTIMMUNGEN

3.1 IDENTIFIZIERUNG DER MASCHINE

Bei jeder Mitteilung an den Hersteller Nuova Simonelli muss die Seriennummer angegeben werden.



3.2 TRANSPORT

Die Maschine wird auf Paletten transportiert, die mehrere Maschinen in großen Kartons enthalten, die wiederum mit Stützhalterungen auf der Palette gesichert sind.

Vor Durchführung der Transport- und Verstellarbeiten muss der Bediener:

- Arbeitshandschuhe, Sicherheitsschuhe und einen Arbeitsanzug mit Gummizügen an den Enden tragen.

Der Transport der Palette muss mit einem geeigneten Hebemittel (Hubwagen) erfolgen.

3.3 HANDLING

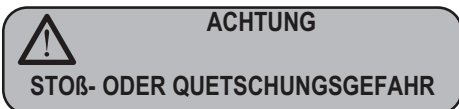

Der Bediener muss während des Verstellens darauf achten, dass sich keine Personen, Dinge oder Gegenstände im

Gefahrenbereich befinden. Die Palette circa 30 cm vom Boden anheben und in die Ladezone transportieren. Nachdem überprüft wurde, dass keinerlei Hindernisse vorhanden sind oder sich Personen bzw. Dinge in der Ladezone befinden, kann mit dem Laden begonnen werden.

Nach Erreichen des Bestimmungsortes, wird mit Hilfe eines geeigneten Hebemittels (z.B.: Hubwagen) abgeladen, nachdem überprüft wurde, dass sich keine Dinge oder Personen in der Abladezone befinden; die Palette auf den Boden stellen, circa 30 cm vom Boden anheben und in den Lagerbereich bringen.

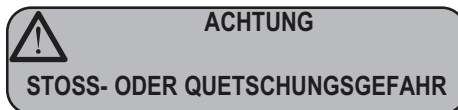

Vor dem nächsten Arbeitsschritt ist zu überprüfen, dass die Ladung unbeschädigt ist und bei Durchschneiden der Stützhalterungen nicht herunterfällt.

Der Bediener muss beim Durchschneiden der Stützhalterungen und Einlagern der Produktes Arbeitshandschuhe und Sicherheitsschuhe tragen. Vor Durchführung dieses Arbeitsschrittes müssen die technischen Eigenschaften des Produktes gelesen werden, um das Gewicht der zu lagernden Maschine zu kennen und sich dementsprechend verhalten zu können.

4. INSTALLATION UND INBETRIEBNAHME

Nach der Verpackungsabnahme und der Überprüfung der Unversehrtheit der Maschine und des Zubehörs ist wie folgt beschrieben vorzugehen:

- Maschine auf eine waagerechte Fläche stellen;
- die Stützfüße der Maschine durch Einführen des Einsatzes in die zylinderförmige Hülse zusammenbauen;
- den Gummifuß in das Gewinde des Einsatzes anschrauben, der sich in der Hülse befindet;
- die soeben montierte Gruppe in die betreffenden Sitze der Maschinenfüße einsetzen;
- Maschine anhand der Regelfüße gerade stellen;

HINWEIS: Die Hüllennuten sind nach oben zu richten; siehe Abbildung unten.

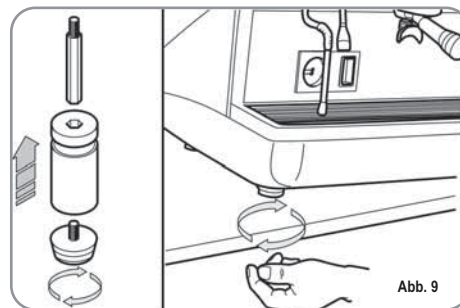

Nachdem die Maschine waagrecht positioniert wurde, empfiehlt es sich, einen Enthärter (1) am Ausgang des Wassernetzes sowie anschließend einen Feinfilter (2) vorzusehen. Auf diese Weise wird eine Beschädigung der empfindlichen Graphitflächen durch Unreinheiten wie Sand, schwebende Kalkteilchen, Rost, usw. verhindert und eine lange Lebensdauer der Maschine gewährleistet.

Nun die Wasseranschlüsse vornehmen – siehe hierzu die nachstehende Abbildung.

ACHTUNG

Der empfohlene Wasserleitungsdruck beträgt [2,3] bar.

ACHTUNG

Verbindungsrohre nicht drosseln. Sicherstellen, dass der Abfluss (3) die Aussonderungen beseitigt.

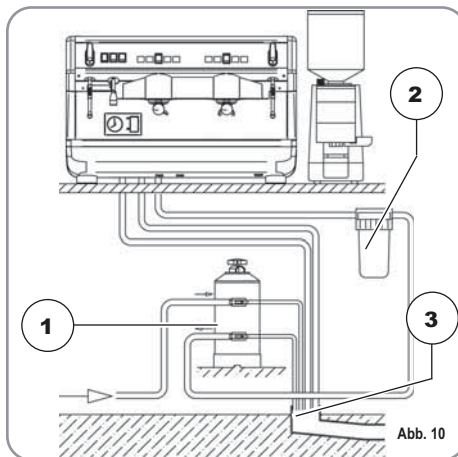

LEGENDE

- 1 Enthärter
- 2 Feinfilter
- 3 Abfluss Ø 50 mm

HINWEIS: Der Netzdruck darf zur Gewährleistung eines einwandfreien Maschinenbetriebs nicht über 4 bar liegen.

Andernfalls ist dem Enthärter ein Druckminderer vorzuschalten; das Rohr am Wassereinlauf hat einen Innendurchmesser von nicht unter 6 mm (3/4") aufzuweisen.

ACHTUNG STROMSCHLAGEGFAHR

Die Maschine muss stets mit einem gei-

gneten, allpoligen Leistungsschutzschalter versehen sein, dessen Kontaktöffnungsabstand gleich 3 mm beträgt oder höher liegt.

Nuova Simonelli trägt keine Haftung für Sach- oder Personenschäden, die auf die Nichtbeachtung der geltenden Sicherheitsvorschriften rückführbar sind.

Vor dem Stromnetzanschluss der Maschine sicherstellen, dass die Datenschildspannung der des Stromnetzes entspricht.

Andernfalls die nächsten Anschlüsse gemäß der zur Verfügung stehenden Stromleitung vornehmen. Dabei wie folgt vorgehen:

- bei V 380 / 3 Phasen + Nullleiter:

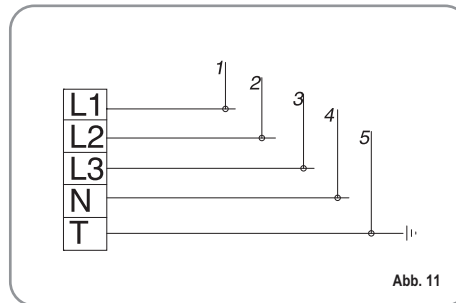

- bei V 230 / einphasig.

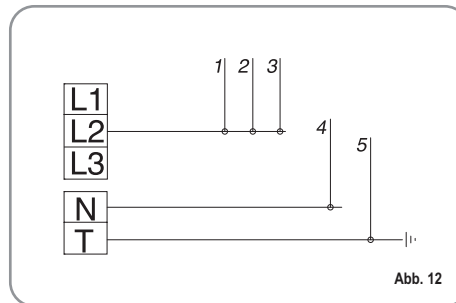

LEGENDE

- 1 Schwarz
- 2 Grau
- 3 Braun
- 4 Blau
- 5 Grüngelb

HINWEIS: Bei Beginn des täglichen Geschäftsbetriebs bzw. bei Unterbrechungen von mehr als 8 Stunden Dauer muss das im Kreislauf der Maschine enthaltene Wasser mithilfe der entsprechenden Vorrichtungen abgelassen und vollständig gewechselt werden.

HINWEIS: Bei Lokalen mit durchgängigem Betrieb muss der vorstehend genannte Wechsel des Wassers mindestens einmal wöchentlich vorgenommen werden.

DEUTSCH

5. EINSTELLUNGEN DURCH DEN FACHMANN



ACHTUNG

NUR der spezialisierte Fachmann darf die nachstehend beschriebenen Regelungen durchführen. Die Nuova Simonelli kann für keinerlei Sach- oder Personenschäden haftbar gemacht werden, die auf die Nichtbeachtung der in dieser Anleitung genannten Sicherheitsvorschriften zurückzuführen sind.

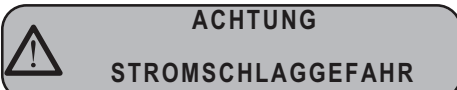

ACHTUNG

STROMSCHLAGGEFAHR

Der spezialisierte Fachmann hat den Maschinenschalter abzuschalten und den Stecker vom Stromnetz abzutrennen, bevor er Regelungen vornimmt.

DEUTSCH

5.1 MANUELLES AUFFÜLLEN DES BOILERS

Alle Modelle *Appia* sind mit einem Füllstandsensoren ausgestattet, der im Boiler einen konstanten Wasserstand beibehält.

Bei der Ersteinrichtung der Maschine sollte der Boiler von Hand gefüllt werden, damit eine Beschädigung des Heizwiderstands und folglich die Einschaltung der elektronischen Sicherung vermieden wird.

Falls sich dies ereignen sollte, genügt es, die Maschine aus- und wieder einzuschalten, um den Füllvorgang zu vervollständigen (siehe Abschnitt „MELDUNGEN MASCHINENFUNKTION – STÖRUNG PEGEL“).

Beim ersten, manuellen Einfüllen wie folgt vorgehen:

- das Tropfgitter der Arbeitsfläche abnehmen;

- den Hahn „A“ von Hand bedienen, damit das Wasser in den Boiler fließt;
- Hahn „A“ schließen, sobald der Mindeststand in der Wasserstandsanzeige erreicht wurde;

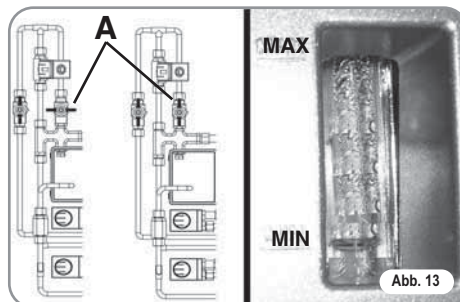

- Maschine durch Positionierung des Hauptschalters auf „I“ einschalten, so dass der Füllstandsensoren aktiviert wird. Der Sensor dient der automatischen Wasserbeibehaltung im Boiler.

5.2 REGELUNG DES PUMPENSCHALTERS

Zur Abänderung des Betriebsdrucks des Boilers und folglich der Wassertemperatur, die sich nach den Anforderungen oder Eigenschaften des benutzten Kaffees richten, ist wie folgt vorzugehen:

- das Tropfgitter der Arbeitsfläche abnehmen;
- den Blechschutz durch Lösen der zwei Seitenschrauben (A), siehe Abbildung unten, abnehmen;



- die Stellschraube der Pumpe für den DRUCKANSTIEG (nach rechts) oder die DRUCKSENKUNG (nach links) betätigen;

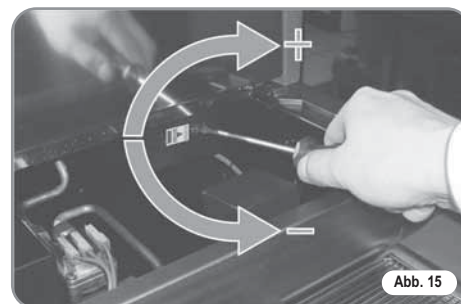

Empfohlener Wert: 1 – 1,4 bar
(je nach Kaffeeart).

- die Stellschraube der Pumpe für den DRUCKANSTIEG (nach rechts) oder die DRUCKSENKUNG (nach links) betätigen;

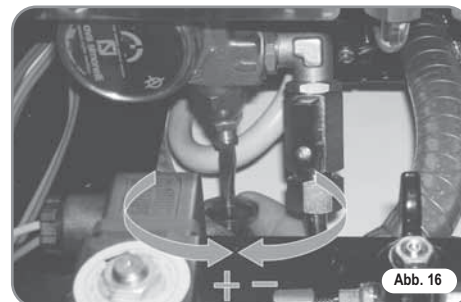

Empfohlener Wert: 9 bar.

- Der eingestellte Pumpendruck wird im unteren Manometerbereich angezeigt.

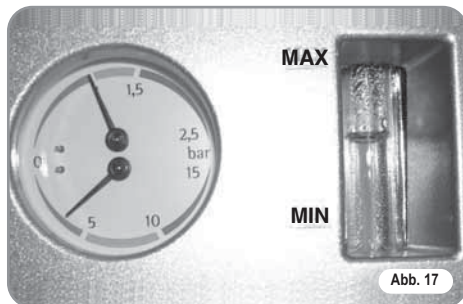

Nach den Einstellungen ist der Blechschutz wieder in seinen Sitz einzusetzen und mit den vier Seitenschrauben zu befestigen. Nun das Tropfgitter wieder auf die Arbeitsfläche legen.

5.3 **REGELUNG DES HEIS- SWASSER-ECONOMI- SERS** (optional Version V/ESSE)

Alle Modelle *Appia* sind mit einem Heißwassermischer ausgestattet, der die Auslauftemperatur des Wassers regelt und die Systemleistung optimiert.

Zur Regelung des Heißwasser-Economisers ist die linke Maschinenplatte abzunehmen. Dabei wie folgt vorgehen:

- die beiden oberen Schrauben lösen (Abb. 18);



- die Schraube neben der Dampfduüse A lösen;
- den Reglerknopf B drücken und die linke Platte abnehmen.

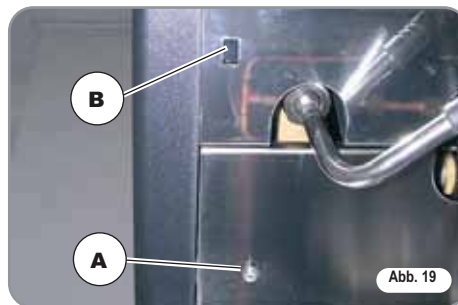

- um die Temperatur des aus der Düse austretenden Heißwassers zu regeln, ist der Reglerknopf IM/GEGEN DEN UHRZEIGERSINN zu drehen, um die Temperatur zu ERHÖHEN/SENKEN;



- die linke Maschinenplatte erneut anbringen, sobald der Vorgang beendet wurde.

5.4 **AUSWECHSLUNG DER DRUCKKNOPFTAFELN**

Der einwandfreie Betrieb sieht bei der Auswechslung die kundenspezifische Gestaltung der einzelnen Druckknopfarten vor. Hierzu sind die Wählschalter der Karten (Tastenseite) wie unten angegeben einzustellen.

GRUPPE	sw1	sw2	sw3	sw4	sw5	sw6
Gruppe 1	On	Off	Off	On	Off	Off
Gruppe 2	Off	On	Off	Off	On	Off
Gruppe 3	Off	Off	On	Off	Off	On

6. GEBRAUCH DER MASCHINE

Der Bediener hat vor dem Gebrauch der Maschine die Sicherheitsvorschriften dieser Anleitung zu lesen und zu verstehen.

6.1 APPIA V

6.1.1 EINSCHALTUNG

- Maschine an das Stromnetz anschließen.
- Hauptschalter (Nr. 13, Abb. 1) auf „ON“ stellen.







Abb. 21

Die LED der Einschalttaste  beginnt zu blinken.

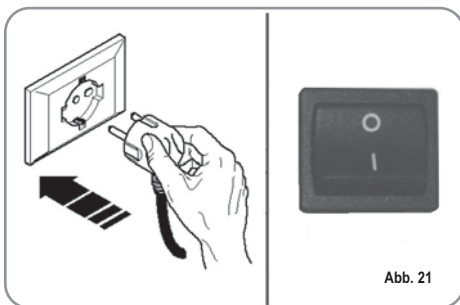
Die Einschalttaste  5 Sekunden lang gedrückt halten;
Nun beginnt der Lamp-test, bei dem alle LEDs eingeschaltet sind. Er endet nach 3 Sekunden, wobei sich die Heißwassertaste  abschaltet.

Die Dauereinschaltung der LED Einschalttaste  und aller LEDs der Abgabetasten zeigen an, dass sich die Maschine im eingeschalteten Zustand befindet.



HINWEIS: Alle Auswahlkosten sind am Ende des Diagnosevorgangs aktiviert.



ACHTUNG

Bei Wartungseingriffen an der Elektronikkarte ist die Maschine anhand des externen Hauptschalters auszuschalten oder das Speisekabel aus der Steckdose zu ziehen.

6.1.2 AUSSCHALTUNG

- Bei der Betätigung und einem etwa 2 Sekunden langem Drücken der Ein-/Abschalttaste  schaltet sich die Maschine aus und die LED der Ein-/Abschalttaste  kehrt wieder in den Blinkzustand zurück.
- Hauptschalter anschließend auf „OFF“ stellen.

6.2 APPIA ESSE

6.2.1 EINSCHALTUNG

- Maschine an das Stromnetz anschließen und Hauptschalter (Nr. 13, Abb. 1) auf „ON“ stellen.

6.2.2 AUSSCHALTUNG

- Hauptschalter (Nr. 13, Abb. 1) auf „OFF“ stellen.

6.3 AUSWAHLARTEN

Die gewünschte Funktion anhand der über den Siebträgern angeordneten, verfügbaren Tasten einstellen (siehe Abschnitt „BESCHREIBUNG“) einstellen.



TASTENERKLÄRUNG (Auswahlarten)



1 Kurzer Espresso



2 Kurze Espresso



1 Langer Espresso



2 Lange Espresso



Dauernd

6.4 ESPRESSOZUBEREITUNG

Siebträger abnehmen und mit einer oder zwei Dosen gemahlenem Kaffee (vom verwendeten Filter abhängig) füllen.



Abb. 23

Den Kaffee mit dem mitgelieferten Stopfer pressen, die Kaffeepulverreste auf dem ringförmigen Siebrand entfernen (dies gewährleistet eine bessere Abdichtung und eine geringere Abnutzung der Dichtung). Nun den Siebträger in die Brühgruppe einsetzen und die gewünschte Espresso-Taste drücken:



1 Kurzer Espresso

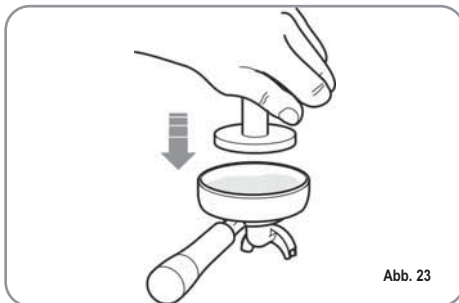

2 Kurze Espresso



1 Langer Espresso



2 Lange Espresso

Die Pumpe schaltet sich ein und das Elektroventil der Brühgruppe öffnet sich, was die Espressoabgabe ermöglicht. Dieser Vorgang wird durch die Einschaltung der gedrückten Taste angezeigt.

HINWEIS: Den Siebträger in den Pausen in der Brühgruppe eingesteckt lassen, damit dieser warm bleibt. Die Brühgruppen sind zur

Gewährleistung der thermischen Höchststabilität während des Betriebs mit einem Heißwasserumlauf thermokompensiert.

6.5 DAMPFGEBRAUCH



**ACHTUNG
VERBRÜHUNGSGEFAHR**

Beim Gebrauch der Dampfduüse dürfen die Hände nicht unter die Düüse gestellt oder diese gleich nach der Benutzung angefasst werden.

Für den Dampfgebrauch ist der betreffende Hebel zu ziehen oder anzudrücken (Abb. 24). Falls er ganz gezogen wird, bleibt er in der maximalen Abgabeleistung. Das Andrücken löst dagegen den automatischen Hebelrücklauf aus. Der gelenkartige Aufbau der beiden Dampfduüsen ermöglicht einen müheloserer Einsatz.



Abb. 24

HINWEIS: Der Verwendung des Dampfrohres muss immer ein mindestens 2 Sekunden langes bzw. den Anweisungen des Herstellers entsprechendes Ablassen des Kondensats vorausgehen.

6.6 CAPPUCCINO-ZUBEITUNG

Zur Erzielung der typischen Crema ist die Dampfduüse bis zum Boden des zu 1/3 gefüllten

Behälters (vorzugsweise kegelstumpfförmig) zu führen und der Dampf zu öffnen. Dampfduüse zur Oberfläche führen, bevor die Milch den Siedepunkt erreicht hat. Dabei senkrecht verlaufende Bewegungen ausführen und nur wenig in die Milch eintauchen. Düüse anschließend mit einem weichen Tuch reinigen.





Abb. 25

6.7 HEISSWASSERWÄHLER

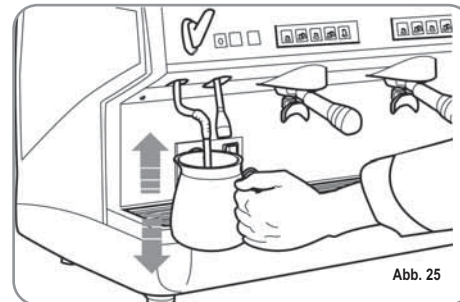

**ACHTUNG
VERBRÜHUNGSGEFAHR**

Beim Gebrauch der Heißwasserduüse dürfen die Hände nicht unter die Düüse gestellt oder diese gleich nach der Benutzung angefasst werden.

Ermöglicht die Heißwasserabgabe für die Zubereitung von Tee und Aufgüssen. Einen Behälter unter die Heißwasserduüse stellen und den Schalter (Version ESSE) oder die Auswahl-taste Heißwasser  (Version V) betätigen.

Sicherstellen, dass sich die Taste einschaltet. Nun strömt aus der Heißluftduüse Wasser heraus; die Dauer dieses Vorgangs entspricht dem programmierten Wert.

HINWEIS: Die Heißwasserabgabe kann zusammen mit der Espressoabgabe erfolgen.

7. PROGRAMMIERUNG Appia V

7.1 ZEICHENERKLÄRUNG

Um Zugriff zu den Programmumgebungen zu erhalten, ist wie folgt vorzugehen:

HINWEIS: Dieser Vorgang ist bei eingeschalteter Maschine ausführbar.

- Um in den Programmierstatus der Dosen jeder Gruppe zu gelangen, ist die Dauerausgabetaste  5 Sek. lang zu drücken.
- Die Ausgabetasten beginnen zu blinken
- Der Zugriff zur Programmierung der ersten Gruppe aktiviert auch die Einstellung der Maschinenbetriebsparameter.

7.2 PROGRAMMIERUNG DER KAFFEEDOSEN

Um die Wasserdosis im Hinblick auf eine der Ausgabetasten programmieren zu können, ist wie folgt vorzugehen:

- Den Filterhalter (dieser kann einzeln als auch doppelt vorliegen, je nach zu programmierender Taste) mit der richtigen Kaffeedosis füllen.
- Den Filterhalter in die Gruppe einführen.
- Eine der Ausgabetasten drücken:



- Die Ausgabe beginnt; nach Erreichen der gewünschten Menge die Dauertaste



drücken.

- Die Ausgabe stoppt und die gewählte Dosistaste schaltet sich aus (die anderen

Tasten blinken weiter).



- Die Dauertaste  drücken, um den Programmierstatus zu beenden oder mit der Programmierung weiterer Dosistasten fortzufahren.

HINWEIS: Dieses Verfahren ist für alle Maschinengruppen einsetzbar, es sei denn, es wird für jeweils immer nur eine Gruppe einzeln durchgeführt. Die anderen Gruppen funktionieren dabei normal weiter.

7.3 HEISSWASSERPROGRAMMIERUNG

- In den Programmierstatus gelangen; hierzu die jeweilige Vorgehensweise befolgen.
- Die Auswahlstaste Heißwasser  drücken.
- Die Heißwasserausgabe beginnt.
- Die gewünschte Heißwasserdosis festlegen und erneut die Taste  betätigen.

- Die Dauertaste  drücken, um den Programmierstatus zu beenden oder mit der Programmierung weiterer Auswahlstasten fortzufahren.

7.4 PROGRAMMIERUNG DES TASSENWÄRMERS (optional)

- Den Programmiermodus der ersten Gruppe wie beschrieben einleiten.
- Die Auswahlstaste Tassenwärmer  drücken.

- Die Abgabetasten der ersten und zweiten Gruppe melden jeweils die automatische Ein- und Abschaltzeit, wobei die Dauertasten  der ersten und zweiten Gruppe blinken.

Nachstehende Tabelle zeigt, dass jeder Abgabetaste ein Wert zugeordnet wurde. Die Einschaltzeit des Tassenwärmers ist die Wertsumme der beleuchteten Tasten der ersten Gruppe. Der gleiche Zählmodus gilt für die Abschaltzeit des Tassenwärmers mit den Tasten der zweiten Gruppe.

Taste	Gruppe 1 (Zeit ON)	Gruppe 2 (Zeit OFF)
	2 min.	5 min.
	4 min.	10 min.
	8 min.	20 min.
	16 min.	40 min.

7.5 PROGRAMMIERUNG DER STANDARDDOSEN

- Für die 4 Dosen der Gruppe und das Wasser (Dampf) können vorherbestimmte Werte eingestellt werden.

Hierzu die Taste  mindestens 10 Sekunden lang gedrückt halten, bis sich die blinkenden Tasten ausschalten.

Die Dosen sind:

1CN	2CN	1CL	2CL
40 cc	60 cc	50 cc	85 cc

WASSER
9 sec.

HINWEIS: Eine Dauer von 0 Sekunden für Wasser und Dampf führt zum Dauerbetrieb.

7.6 DOSEN KOPIEREN

Es besteht die Möglichkeit, die für die Gruppe 1 gespeicherten Dosen in die Dosen der Gruppe 2 der 3 zu kopieren.



Hierbei die Dauertaste  der Gruppe 2 oder 3 mindestens 8 Sekunden lang gedrückt halten, bis sich die blinkenden Tasten abschalten.

7.7 PROGRAMMIERUNG DER BETRIEBSPARAMETER



ACHTUNG

NUR der spezialisierte Fachmann darf die nachstehend beschriebenen Einstellungen durchführen.

Bei der Betätigung der Taste  der zweiten Gruppe wird nach dem Eingang in den Programmiermodus der ersten Gruppe die Einstellung der Maschinenbetriebsparameter eingeblendet, was durch die Einschaltung der Dauertaste der zweiten Gruppe  angezeigt wird.

- Aktivierung der Pumpe, sofern der Füllstand aktiviert ist.
- Aktivierung der Softwaresperre für den Eingang in die Dosenprogrammierung.
- Regelung der Tastaturhelligkeit.
- Aktivierung der Pumpe mit Heißwasser (bei Maschinen mit Economiser).
- Deaktivierung des Tassenwärmers.
- Wiederherstellung der Standardparameter.

1. Activation pompe pendant le niveau.

Die Taste kurzer Kaffee  der zweiten Gruppe stellt die Pumpenaktivierung während des Füllstands ein:

Ist die Taste  eingeschaltet, aktiviert sich die Pumpe zusammen mit dem Füllstand; ist sie ausgeschaltet, kommt es zu keiner Pumpenaktivierung mit Füllstand.

2. Aktivierung der Softwaresperre für den Eingang in die Dosenprogrammierung.

Die Taste dünner Kaffee  aktiviert die Softwaresperre für die Programmierung der Dosen (Taste an) oder deaktiviert die Sperre (Taste aus).

3. Regelung der Tastaturhelligkeit.

Die blinkende Taste 2 dünne Kaffees  der zweiten Gruppe dient der Auswahl der Tastenelligkeit und sieht 5 voreingestellte Stufen auf.

Bei Betätigung der blinkenden Taste  ändert sich die Stufe, indem der Wert bis zum Minimum gesenkt wird, um anschließend wieder zum Höchstwert zurückzukehren.

4. Aktivierung der Pumpe mit Heißwasser (nur für Maschinen mit Economiser).

Mit der Heißwassertaste  ist während der Wasserabgabe die Pumpenaktivierung einstellbar.



Bei eingeschalteter Taste  aktiviert sich die Pumpe während der Heißwasserabgabe; ist die Taste dagegen ausgeschaltet, kommt es zu keiner Pumpenaktivierung.

5. Deaktivierung des Tassenwärmers.

Die Taste  aktiviert oder deaktiviert den Tassenwärmerbetrieb. Bei eingeschalteter Taste funktioniert der Tassenwärmer gemäß den Programmeinstellungen; ist die Taste dagegen ausgeschaltet, ist der Tassenwärmer deaktiviert.



Bei deaktiviertem Tassenwärmer schaltet sich die Taste  nur beim Lamp-test ein.

Anschließend bleibt jeglicher Tastendruck ohne Wirkung.

Bei Betätigung der Dauertaste  der zweiten Gruppe werden die abgeänderten Werte gespeichert. Die Seite mit den Einstellungen  der Maschinenbetriebsparameter wird ausgeblendet.



6. Wiederherstellung der Standardparameter



Die Standardparameter, d.h. Füllstand der Pumpe, Wasser mit Pumpe, max. Helligkeit und Tassenwärmer aktiviert sind wieder herstellbar.

Zur Wiederherstellung dieser Parameter genügt es, die Maschine über die Taste  einzuschalten. Dabei die Taste 2 kurze Kaffees  und 2 dünne Kaffees  der

ersten Gruppe gleichzeitig gedrückt halten.



7.8 AUTOMATISCHER GRUPPENREINIGUNGSZYKLUS



Um in den Status automatische Reinigung zu gelangen, ist die Maschine ab- und wieder einzuschalten, indem während des einleitenden Lamp-tests die Tasten Heißwasser  und Tassenwärmer  gedrückt werden.

Nach dem Lamp-test beginnen die Tasten  ,  und die Tasten ein dünner Kaffee  aller Gruppen zu blinken.



Bei der Betätigung der Taste  wird der Waschzyklus der betreffenden Gruppe eingeleitet.

Nach dem Waschzyklus kann für dieselbe Gruppe der Spülzyklus vorgenommen werden, indem erneut die Taste  betätigt wird.

Soll der Spülzyklus zu einem späteren Zeitpunkt ausgeführt werden, ist einzig allein die Maschine abzuschalten: Die Karte behält die Speicherung der zu beendenden Reinigungszyklen bei. Bei der darauffolgenden Einschaltung wird die Karte automatisch in den Status Gruppenreinigung gelangen, ohne hierfür die Tasten  und  drücken zu müssen.

Die 2 Sekunden lange Betätigung der Tasten  und  schließt den Reinigungsstatus, sofern keine zu beendenden Zyklen vorliegen. Andernfalls blinken weiterhin die Tasten  der Gruppen, in denen

noch der Spülzyklus auszuführen ist.

Werden die Tasten  und  für weitere 2 Sekunden gedrückt, wird die Schließung des Reinigungsstatus forciert, indem die Angabe über die noch zu beendenden Spülverfahren auf Null gestellt wird.

Die Taste  der Gruppe schaltet sich ab, sobald der Reinigungszyklus beendet wurde.

Die Karte schließt den Reinigungsstatus, sobald keine weiteren Spülverfahren mehr vorliegen.

8. REINIGUNG UND PFLEGE

Im Fall von Instandhaltungs-/Reparaturarbeiten müssen die jeweils verwendeten Bauteile die gleichen Hygiene- und Sicherheitsbedingungen gewährleisten, die für diese Maschine vorgesehen sind.

Originalersatzteile bieten diese Gewähr. Nach Reparatur oder Austausch von Bauteilen, die mit Wasser und Nahrungsmitteln in Berührung kommen, muss deren Reinigung vorgenommen werden, wie vom Hersteller vorgeschrieben.

8.1 STOPP

Die Maschine auf den Stromzustand „OFF“ setzen (der Maschinenschalter ist aus und der Stecker abgezogen), bevor Reinigungsarbeiten vorgenommen werden.



Abb. 26

8.2 GEHÄUSEREINIGUNG

Bevor Reinigungsarbeiten jeglicher Art vorgenommen werden, muss die Maschine von der Stromversorgung getrennt werden (d.h. Maschinenschalter ausgeschaltet und Trennschalter offen).



ACHTUNG

Keine Lösungsmittel, chlorhaltigen Erzeugnisse, Scheuermittel verwenden.



ACHTUNG

Das Gerät darf nicht mit dem Wasserstrahl oder durch Eintauchen in Wasser gereinigt werden.

Reinigung der Arbeitsfläche: Die Vorderseite des Tropfgitters von der Arbeitsfläche anheben und herausziehen. Die darunter liegende Abtropfschale abnehmen und das Ganze mit heißem Wasser und Reinigungsmittel waschen. **Gehäusereinigung:** Benutzen Sie für die Reinigung der verchromten Teile ein angefeuchtetes, weiches Tuch.

8.3 REINIGUNG DER EDELSTAHLBRAUSEN

Die Edelstahlbrausen befinden sich unter den Brühgruppen. Siehe Abb. 27.



Abb. 27

HINWEIS:wie folgt reinigen:

- Die Schraube in der Brausenmitte lösen.
- Brause abziehen und sicherstellen, dass keine verstopften Löcher vorliegen.
- Bei Verstopfungen gemäß Beschreibung (Abschnitt „REINIGUNG DER FILTERE UND SIEBTRÄGER“) reinigen.

Brausen wöchentlich reinigen.

8.4 GRUPPENREINIGUNG MIT BLINDFILTER

Die Maschine sieht das Waschen der Brühgruppe unter Einsatz eines spezifischen Pulverpflegeprodukts vor.

Die Reinigung sollte mindestens ein Mal täglich mit den dafür vorgesehenen Pflegeprodukten vorgenommen werden.



**ACHTUNG
VERGIFTUNGSGEFAHR**

Nach Abnahme des Siebträgers sind zur Behebung eventueller Reinigungsmittelrückstände einige Abgaben vorzunehmen.

Beim Waschzyklus wie folgt vorgehen:

- 1) Den Sieb durch den Blindfilter der Brühgruppe ersetzen.
- 2) Den Blindfilter mit zwei Löffeln spezifisches Pulverreinigungsmittel füllen und Siebträger in die Gruppe einstecken.
- 3) Eine der Kaffeetasten drücken und nach 10 Sek. abstellen.
- 4) Vorgang mehrmals wiederholen.
- 5) Siebträger abnehmen und einige Abgaben durchführen.

8.5 REINIGUNG DER FILTER UND SIEBTRÄGER

Zwei Teelöffel spezifisches Reinigungsmittel in einen halben Liter heißes Wasser geben und darin Filter und Siebträger (ohne Griff) eintauchen und dort mindestens eine halbe Stunde lassen. Anschließend mit reichlich fließendem Wasser ausspülen.

DEUTSCH

8.6 ERNEUERUNG DER ENTHÄRTERHARZE

Zur Vermeidung von Kalkablagerungen im Boiler und in den Wärmeaustauschern hat der Enthärter in einem stets einwandfreien Zustand zu sein. Folglich sind die Ionenharze in regelmäßigen Abständen zu erneuern.

Die Regenerierungszeiten sind im Hinblick auf die täglich benutzte Kaffeemenge und die Wasserhärte festzusetzen.

Das Diagramm der Abb. 28 zeigt einige richtunggebende Werte an.



Abb. 28

Die Erneuerung sieht folgende Schritte vor:

1) Maschine ausschalten und einen Behälter mit einem Fassungsvermögen von mindestens 5 Litern unter das Rohr E stellen (Abb. 29).

Die Hebel C und D von links nach rechts drehen; den Verschluss durch Abschrauben des Drehknopfes G abnehmen und 1 kg grobes Kochsalz einfüllen (Abb. 30).

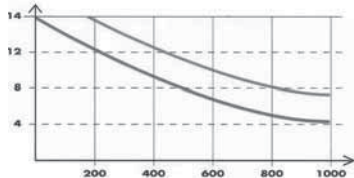

Abb. 29



Abb. 30

2) Den Verschluss wieder einsetzen und den Hebel C wieder nach links führen (Abb. 31). Dabei hat das Salzwasser durch das Rohr F zu fließen, bis wieder Süßwasser vorliegt (1/2 Stunde).

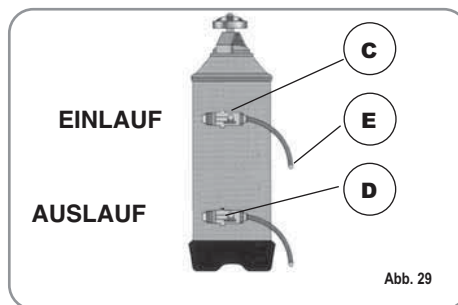

Abb. 31

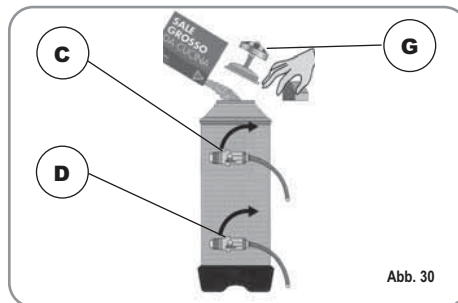
3) Hebel D wieder nach links führen (Abb. 32).





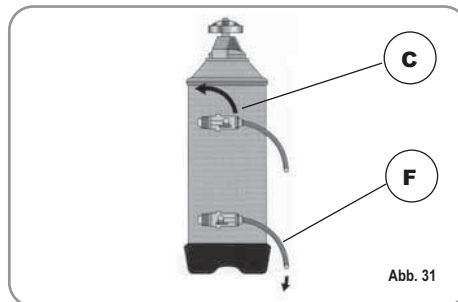

Abb. 32

9. MELDUNGEN MASCHINENFUNKTIONEN Appia V

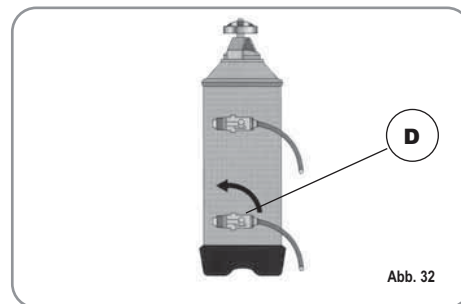
DISPLAY- UND TASTENANGABEN	URSACHE	WIRKUNG	LÖSUNG	HINWEIS
Zeichnung blinkende Dauertaste  und fixe Ausgabetaste 	Falls der Dosierer innerhalb der ersten drei Sekunden ab dem Abgabebeginn nicht die programmierten Impulse sendet.	Falls die Abgabe nicht von Hand unterbrochen wird, kommt es zur Zeitlimitsperre.	Ausgabe unterbrechen.	
Zeichnung blinkende Dauertaste 	Falls der Stand 90 Sek. nach dem Beginn bei eingeschalteter Pumpe im Hochpegel oder nach 180 Sek. bei deaktivierter Pumpe nicht wieder hergestellt wurde.	Die Pumpe schaltet sich ab. Die Widerstände und Funktionen sind deaktiviert.	Maschine mindestens 5 Sek. aus- und dann wieder einschalten.	

Enhorabuena,

con la compra del modelo *Appia* usted ha hecho una elección inmejorable.

La adquisición de una máquina de café expres profesional implica varios factores de selección: el nombre de la empresa productora, las funciones específicas de la máquina, la fiabilidad técnica, la posibilidad de una asistencia disponible y adecuada, el coste. Usted claramente ha valorado todo ésto y después ha decidido: elijo el modelo *Appia*.

Para nosotros, ha elegido el mejor producto y se podrá dar cuenta, después de cada café y después de cada capuchino.

Verá la comodidad, lo práctico y eficiente que es trabajar con *Appia*.

Si es la primera vez que compra una máquina de café "Nuova Simonelli", bienvenido a la alta cafetería; si ya es un cliente nuestro, nos sentimos halagados por su fidelidad.

Gracias por su elección.

Cordialmente,

Nuova Simonelli S.p.a.



Appia[®]
MADE IN ITALY

ESPAÑOL

CARACTERÍSTICAS TÉCNICAS

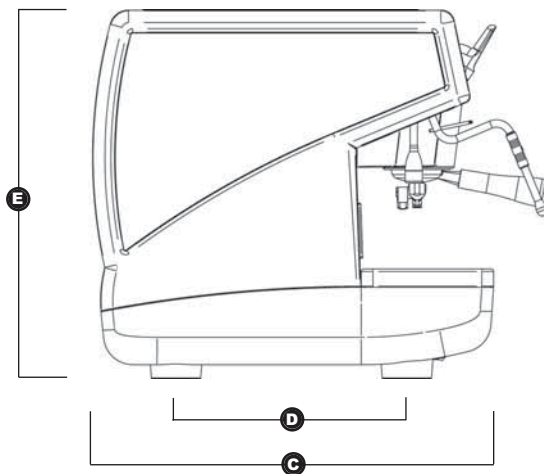
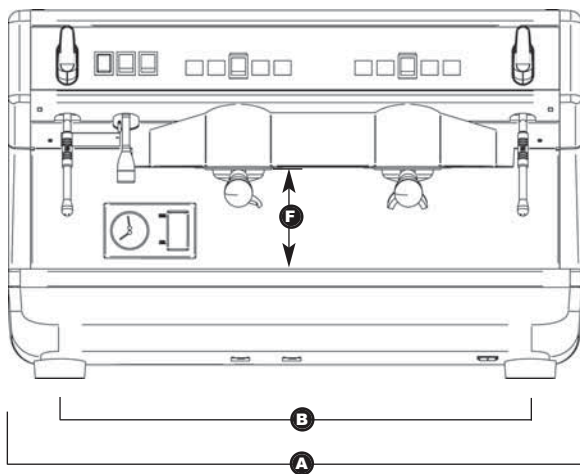

	2 Grupos		3 Grupos	
PESO NETO	60 kg	133 lb	74 kg	163 lb
PESO BRUTO	65 kg	143 lb	80 kg	176 lb
POT. TÉRMICA	3000 W	3000 W	5000 W	5000 W
MEDIDAS	A 785 mm	A 30 ⁷ / ₈ "	A 1010 mm	A 39 ⁷ / ₈ "
	B 690 mm	B 27 ¹ / ₈ "	B 920 mm	B 36 ³ / ₁₆ "
	C 545 mm	C 21 ⁷ / ₁₆ "	C 545 mm	C 21 ⁷ / ₁₆ "
	D 370 mm	D 14 ⁹ / ₁₆ "	D 370 mm	D 14 ⁹ / ₁₆ "
	E 530 mm	E 20 ¹ / ₁₆ "	E 530 mm	E 20 ¹ / ₁₆ "
	F 135 mm	F 5 ¹ / ₈ "	F 135 mm	F 5 ¹ / ₈ "

INDICE

CARACTERISTICAS TECNIVAS46

1.	DESCRIPCIÓN	49
1.1	LISTA DE ACCESORIOS	50
2.	PRESCRIPCIONES DE SEGURIDAD	51
3.	TRANSPORTE Y GESTIÓN	54
3.1	IDENTIFICACIÓN MÁQUINA	54
3.2	TRANSPORTE	54
3.3	GESTIÓN	54
4.	INSTALACIÓN Y OPERACIONES	
	PRELIMINARES	54
5.	REGLAGES DU TECHNICIEN QUALIFIE	56
5.1	LLENADO MANUAL DE LA CALDERA	56
5.2	REGULACIÓN PRESOSTATO / BOMBA	56
5.3	REGULACIÓN ECONOMIZADOR AGUA CALIENTE (versión opcional V/ESSE)	57
5.4	SUSTITUCIÓN DE LOS PULSADORES	57
6.	UTILIZACIÓN	58
6.1	APPÍA V	58
6.1.1	ENCENDIDO	58
6.1.2	APAGADO	58
6.2	APPÍA ESSE	58
6.2.1	ENCENDIDO	58
6.2.2	APAGADO	58
6.3	CONFIGURACIÓN DE LA SELECCIÓN	58
6.4	PREPARACIÓN DEL CAFÉ	59
6.5	UTILIZACIÓN DEL VAPOR	59
6.6	PREPARACIÓN DEL CAPPUCCINO	59
6.7	SELECCIÓN DE AGUA CALIENTE	59
7.	PROGRAMACIÓN APPÍA V	60
7.1	PROGRAMMACION DOSIS	60
7.2	PROGRAMACIÓN DOSIS CAFÉS	60
7.3	PROGRAMACIÓN AGUA CALIENTE	60
7.4	PROGRAMACIÓN CALIENTA-TAZAS (opcional)	60
7.5	PROGRAMACIÓN DOSIS ESTÁNDAR	61
7.6	COPIAR DOSIS	61

7.7	PROGRAMACIÓN PARÁMETROS DE FUNCIONAMIENTO	61
7.8	CICLO AUTOMÁTICO DE LIMPIEZA GRUPOS	62
8.	LIMPIEZA Y MANTENIMIENTO	63
8.1	DETENCIÓN	63
8.2	LIMPIEZA EXTERIOR	63
8.3	LIMPIEZA DE LAS ROSETAS INOXIDABLES	63
8.4	LIMPIEZA DEL GRUPO CON LA AYUDA DEL FILTRO CIEGO	63
8.5	LIMPIEZA DE LOS FILTROS Y PORTAFILTROS	63
8.6	REGENERACIÓN DE LAS RESINAS DEL ENDULZANTER	64
9.	MENSAJES FUNCIONES MÁQUINA	
	APPÍA V	65
	INSTALACIÓN ELÉCTRICA	
	APPÍA ESSE 2/3 GRUPOS	68
	INSTALACIÓN ELÉCTRICA	
	APPÍA V 2 GRUPOS	70
	INSTALACIÓN ELÉCTRICA	
	APPÍA V 3 GRUPOS	72
	INSTLACIÓN HIDRÁULICA	74

Appia[®]
MADE IN ITALY

1. DESCRIPCIÓN *Appia V - Esse*

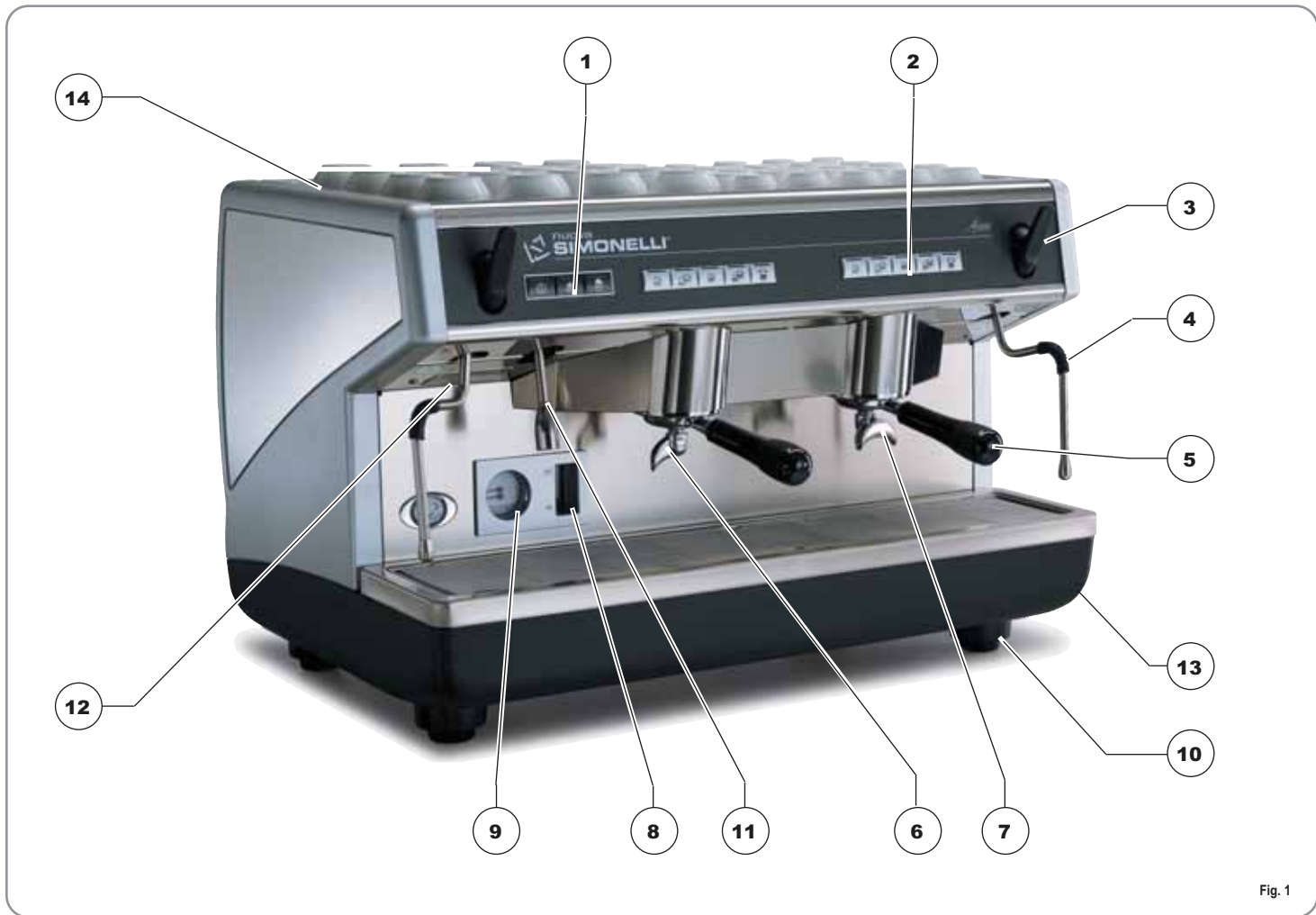

Fig. 1

LEYENDA

- | | |
|-------------------------|---------------------------|
| 1 Pulsantes selección | 9 Manómetro |
| 2 Pulsantes erogación | 10 Pie regulable |
| 3 Mando vapor | 11 Lanzador agua caliente |
| 4 Lanzador vapor | 12 Placa datos |
| 5 Portafiltro | 13 Main switch |
| 6 Single delivery spout | 14 Cup warmer (optional) |
| 7 Double delivery spout | |
| 8 Nivel óptico | |

1.1 LISTA DE ACCESORIOS

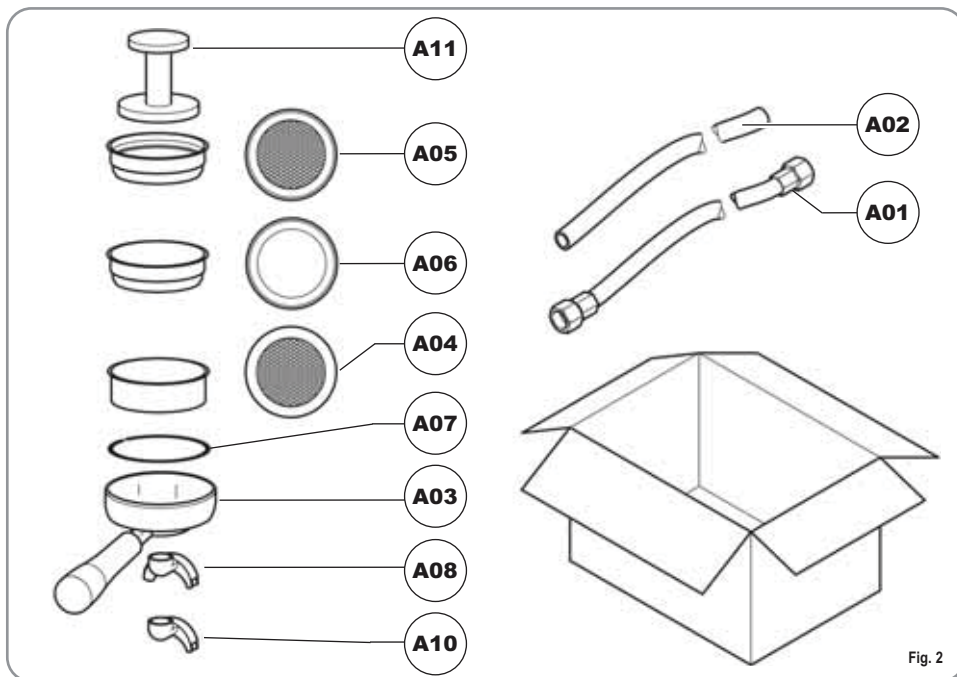



Fig. 2

CÓDIGO	DESCRIPCIÓN	2 GRUPOS	3 GRUPOS
A01	Tubo carga 3/8"	1	1
A02	Tubo descarga Ø 25 mm. - L. 150 cm.	1	1
A03	Portafiltro	3	4
A04	Filtro doble	2	3
A05	Filtro individual	1	1
A06	Filtro ciego	1	1
A07	Muelle	3	4
A08	Pico de erogación doble	2	3
A09	Pico de erogación individual	1	1
A10	Prensa café	1	1

2. PRESCRIPCIONES DE SEGURIDAD

 El presente manual constituye parte integrante y esencial del producto y tendrá que ser entregado al usuario. Leer atentamente las advertencias contenidas en el presente manual ya que proporcionan importantes indicaciones referidas a la seguridad de instalación, de uso y mantenimiento. Conservar con cuidado este libro de instrucciones para cualquier ulterior consulta.

 Después de haber quitado el embalaje asegurarse de la integridad del aparato. En caso de duda no utilizar el aparato y dirigirse al personal profesionalmente cualificado. Los elementos de embalaje (saquitos de plástico, poliespan, clavos, etc.) no se deben dejar al alcance de los niños ya que son potenciales fuentes de peligro, ni ser abandonados en el medio ambiente.



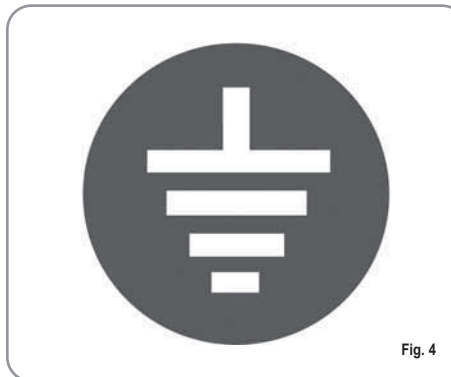

 Antes de conectar el aparato asegurarse que los datos de la placa correspondan a aquellos de la red de distribución eléctrica. La placa está situada en el frontal de la máquina en alto a la derecha. La instalación tiene que ser efectuada de acuerdo con las normas vigentes, según las instrucciones del constructor y del personal cualificado.

El constructor no se puede considerar responsable por eventuales daños causados por la falta de la toma de tierra en la instalación. Para la seguridad eléctrica de este aparato es obligatorio predisponer la instalación de toma de tierra, dirigiéndose a un electricista autorizado, que tendrá que comprobar que el alcance eléctrico de la instalación sea adecuado a la potencia máxima del aparato indicada en la placa de características identificadora.



 En particular tendrá que asegurarse que la selección de los cables de la instalación sea adecuada a la potencia absorbida por el aparato. Está prohibido el uso de adaptadores, tomas múltiples y prolongadores. En caso de que su uso sea indispensable es necesario llamar a un electricista autorizado.

 Para los aparatos alimentados a 220-230V, la máxima impedancia suministrada por la red de alimentación no tiene que superar los 0,37 ohm..

 El instalador debe realizar las líneas hidráulicas respetando las normas de higiene y seguridad hidráulica a la protección del medio ambiente vigentes en el lugar de instalación. Por tanto para ello es necesario llamar a un técnico autorizado.

 La alimentación del dispositivo se tiene que efectuar con agua idónea para el consumo humano conforme a las disposiciones vigentes en el lugar de instalación. El instalador tiene que adquirir del propietario/gestor del sistema confirmación de que el agua respete los requisitos arriba mencionados.

 Durante la instalación del dispositivo se tienen que usar los componentes y los materiales en dotación con el mismo dispositivo.

Si fuera necesario emplear otros componentes, el instalador tiene que verificar la idoneidad de los mismos para utilizarlos en contacto con el agua para consumo humano.

 Este aparato tendrá que ser destinado sólo al uso descrito en este manual. El constructor no se puede responsabilizar de eventuales daños causados por usos inadecuados, erróneos e irrazonables.

 El aparato no es adecuado para el empleo por parte de niños, personas con reducidas capacidades físicas, sensoriales o mentales, o carentes de conocimientos a no ser que exista una supervisión o instrucción.

 Las temperaturas máximas y mínimas de almacenamiento tienen que estar comprendidas en el arco de [-5,+50] C°.

 La temperatura de funcionamiento tiene que estar comprendida entre [+5, +35]°C.

 Al acabar la instalación, el dispositivo es activado y llevado hasta la condición nominal de trabajo dejándolo en condiciones de "listo para el funcionamiento".

Sucesivamente el dispositivo es apagado y todo el circuito hidráulico es vaciado de la primera agua introducida para eliminar eventuales impurezas iniciales.

A continuación el dispositivo es de nuevo cargado y llevado hasta las condiciones nominales de funcionamiento.

Después de alcanzar el estado de "listo para el funcionamiento" se efectúan las siguientes erogaciones:
- 100% del circuito café a través del erogador café (para más erogadores hay que dividir en igual medida);

- 100% del circuito agua caliente a través del erogador agua (para más erogadores hay que dividir en igual medida);
- abertura de cada una de las salidas vapor durante 1 minuto

Al acabar la instalación sería una buena norma redactar un informe de todo lo efectuado.



ATENCIÓN

En el caso de las máquinas que no cuentan con enchufe de conexión a la toma eléctrica es necesario preinstalar la red con un seccionador que seccione cada fase.

 El uso de cualquier aparato eléctrico conlleva el cumplimiento de algunas reglas fundamentales.

En particular:

- no tocar el aparato con manos o pies mojados;



ATENCIÓN

PELIGRO DE DESCARGA ELÉCTRICA

- no usar el aparato con los pies descalzos;
- no usar, prolongadores en locales destinados al baño o ducha;
- no estirar el cable de alimentación, para desconectar el aparato de la red eléctrica;
- no dejar expuesto el aparato a agentes atmosféricos (lluvia, sol, etc.);
- no dejar que el aparato lo usen los niños, o personas no autorizadas y que no hayan leído y comprendido este manual.

 El técnico autorizado debe, antes de efectuar cualquier operación de mantenimiento, apagar el interruptor de la máquina y desconectar el enchufe o abrir el seccionador.

 Para las operaciones de limpieza atenerse únicamente a lo previsto en el siguiente manual.

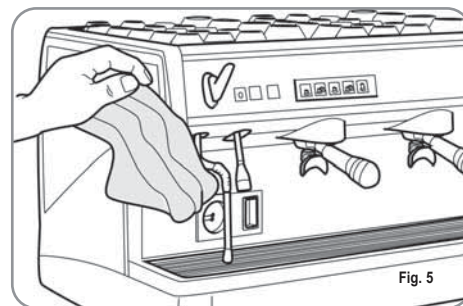



 En caso de avería o de mal funcionamiento del aparato, apagarlo. Está severamente prohibido intervenir. Dirigirse exclusivamente al personal profesionalmente cualificado.

La eventual reparación de los productos tendrá que ser efectuada solamente por la casa constructora o por un centro de asistencia autorizado utilizando exclusivamente recambios originales.

El no respetar las normas mencionadas precedentemente puede comprometer la seguridad del aparato.

 En la instalación, el electricista autorizado tendrá que haber previsto un interruptor omnipolar como está previsto por la normativa de seguridad vigente con distancia de apertura de los contactos igual o superior a 3 mm.

 Para evitar sobrecalentamientos peligrosos se aconseja desenrollar en toda su longitud el cable de alimentación.

 No obstruir las rejillas de aspiración y/o de disipación en particular del calentatazas.

 El cable de alimentación de este aparato no tiene que ser sustituido por el usuario. En caso de que se haya dañado, apagar el aparato y para su sustitución dirigirse exclusivamente al personal profesionalmente cualificado.

 Los aparatos monofásicos con corriente superior a 15A y los aparatos trifásicos vendidos sin enchufe están conectados a la instalación de alimentación eléctrica directamente a través del cable; no es posible por lo tanto el empleo de un enchufe.

 Cuando se decida no utilizar más un aparato de este tipo se aconseja hacerlo inoperante, después de haber desconectado el enchufe, cortando el cable de alimentación.

 **ATENCIÓN**
PELIGRO DE CONTAMINACIÓN

 No dejar abandonada la máquina en el medio ambiente : para deshacerse de la máquina dirigirse a un centro autorizado o contactar al constructor que dará indicaciones al respecto.

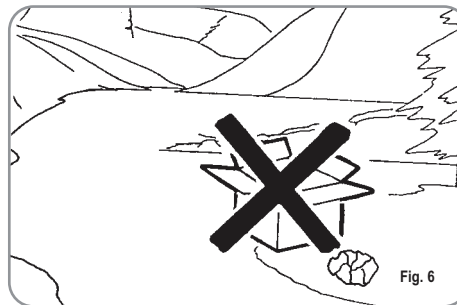



Fig. 6

 **ATENCIÓN**
PELIGRO DE INTOXICACIÓN

 Durante el uso del lanzado del vapor, prestar mucha atención y no poner las manos debajo de él y no tocarlo inmediatamente después del uso.

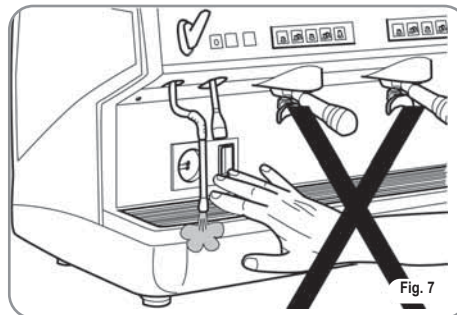





Fig. 7

 **ATENCIÓN**
PELIGRO DE QUEMADURAS

 Recordar que antes de efectuar cualquier operación de instalación, manutención, descarga, regulación, el usuario cualificado tiene que ponerse los guantes de trabajo y los zapatos contra los accidentes.

 El máximo nivel de ruidos emitidos es inferior a los 70db.

 El tubo en la conexión hidrica si se sustituye no se puede reutilizar.

 **ATENCIÓN**

 **INFORMACIÓN PARA LOS USUARIOS**

Bajo los sentidos del art. 13 del Decreto Ley del 25 de julio de 2005, n. 151 "realización de las Normas 2002/95/CE, 2002/96/CE y 2003/108/CE, relativas a la reducción del uso de sustancias peligrosas en los aparatos eléctricos y electrónicos, además del vaciado de los residuos y desechos".

El símbolo del contenedor listado, indicado sobre la instrumentación, indica que el producto al final de su vida útil tiene que ser recogido separadamente de los demás residuos o desechos. El usuario deberá, por tanto, entregar la instrumentación junta al fin vida a los idóneos centros de recogida selectiva de residuos electrónicos y electrotécnicos, o bien recobrarla al detallista al momento del adquiero de una nueva instrumentación de tipo equivalente, en razón de uno a uno. La adecuada recogida selectiva para el envío siguiente de la instrumentación cesada al reciclaje, al trato y al vaciado ecológicamente compatible contribuye a evitar posibles efectos negativos sobre el entorno y sobre la salud y favorece el reciclaje de los materiales que componen la instrumentación. El vaciado abusivo del producto por parte del usuario comporta la aplicación de las sanciones administrativas establecidos por Decreto Ley .22/1997" (art. 50 y siguientes del Decreto Ley n.22/1997.

3. TRANSPORTE Y GESTIÓN

3.1 IDENTIFICACIÓN MÁQUINA

Para cualquier comunicación con el constructor Nuova Simonelli, citar siempre el número de placa de características de la máquina.



3.2 TRANSPORTE

La máquina se transporta en palés con más máquinas dentro de cajas aseguradas al palé con unas cintas.

Antes de proceder con cualquier operación de transporte o movimiento, el usuario debe:

- ponerse guantes y zapatos contra los accidentes y un mono con gomas en los extremos.

El transporte en palés debe ser efectuado con un medio de elevación adecuado (tipo carretilla elevadora).

3.3 GESTIÓN

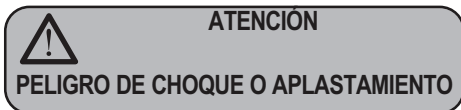

El encargado durante todo el proceso de movimiento, ha de poner atención en que no haya personas, cosas u objetos en el área de trabajo. Levantar lentamente el palé aproximadamente 30 cm. desde el suelo e ir a la zona de carga. Después de haber comprobado que no haya obstáculos, cosas o personas, proceder con la carga.

Una vez llegados al destino, siempre con un medio de elevación adecuado (tipo carretilla elevadora), después de haberse asegurado que no haya cosas o personas en el área de descarga, llevar el palé al suelo y llevarlo a aproximadamente 30 cm. del suelo, hasta el área de almacenamiento.

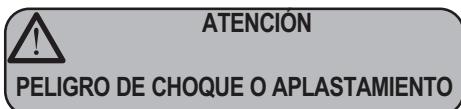

Antes de la siguiente operación comprobar que la carga esté bien y que con el corte de las cintas no se caiga.

El encargado con guantes y zapatos contra los accidentes, tiene que proceder al corte de las cintas y al almacenamiento del producto, para esta operación consultar las características técnicas del producto para ver el peso de la máquina que hay que almacenar y poder regularse en consecuencia.

4. INSTALACIÓN Y OPERACIONES PRELIMINARES

Luego de haber quitado el embalaje y haber controlado el buen estado de la máquina y de los accesorios, proceder como se describe a continuación:

- posicionar la máquina en un plano horizontal;
- ensamblar los pies de apoyo de la máquina introduciendo el encastre dentro del casco cilíndrico;
- enroscar el pie de goma en el roscado del encastre ubicado en el casco;
- enroscar todo el grupo ensamblado en el alojamiento de los pies de la máquina;
- colocar la máquina en una superficie plana ajustando los pies de regulación;

NOTA: la acanaladura del casco se debe invertir hacia arriba, como se muestra en la siguiente figura.

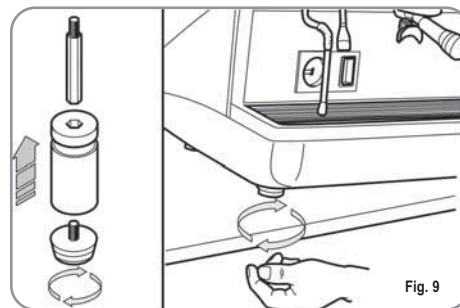

En la fase previa, luego de haber colocado la máquina en la superficie plana, se aconseja instalar un endulzante (1), en la salida de la red hídrica, y luego un filtro de red (2). Esto impide que las impurezas, como la arena, partículas de sarro en suspensión, herrumbre, etc. dañen las delicadas superficies de grafito, garantizando una larga duración de la máquina.

Una vez realizadas estas operaciones, realizar las conexiones hidráulicas como se muestra en la siguiente figura



ATENCIÓN

La presión de la red hídrica aconsejada es [2,3] bar.



ATENCIÓN

Evitar estrangulamientos en los tubos de conexión. Controlar también que la descarga (3) sea capaz de eliminar los desechos.

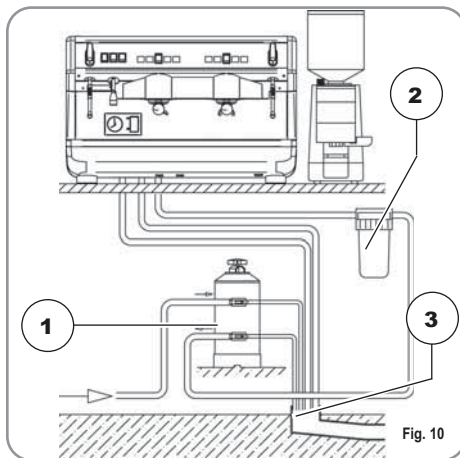

Fig. 10

LEYENDA

- 1 Endulzante
- 2 Filtro de red
- 3 Descarga Ø 50 mm

NOTA: Para un buen funcionamiento de la máquina es necesario que la presión de red no supere los 4 bar. En caso contrario, instalar un reductor de presión antes del endulzante; el tubo de entrada del agua debe tener un diámetro interior no inferior a los 6 mm ($\frac{3}{8}$ ").

ATENCIÓN PELIGRO DE DESCARGA ELÉCTRICA

La máquina debe estar siempre protegida con un interruptor automático monofásico de potencia adecuada que tenga una distancia de apertura de los contactos igual o superior a 3 mm.

Nuova Simonelli no se responsabiliza por ningún daño a objetos o personas provocados por el incumplimiento de las normas de seguridad vigentes.

Antes de conectar la máquina a una red eléctrica controlar que el voltaje indicado en la placa de datos de la máquina corresponda al de la red.

En caso contrario, realizar las siguientes conexiones en base a la línea eléctrica presente, como se muestra a continuación:

- para voltaje **V 380 / 3 fases +Neutro:**

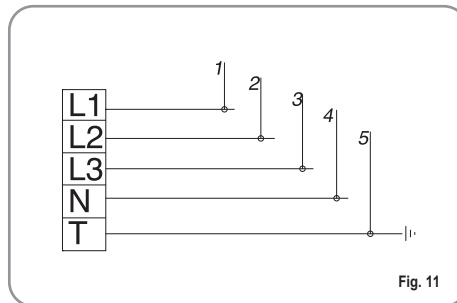

Fig. 11

- para voltaje **V230/ monofásica:**

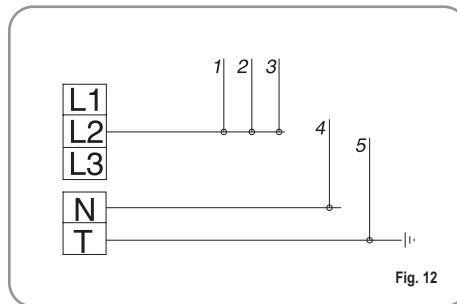

Fig. 12

LEYENDA

- | | |
|----------|--------------------|
| 1 Negro | 4 Azul |
| 2 Gris | 5 Amarillo verdoso |
| 3 Marrón | |

NOTA: Al principio de la actividad diaria y de todas formas en el caso en que haya pausas mayores de 8 horas hay que proceder a efectuar el recambio del 100% del agua contenida en los circuitos utilizando los erogadores adjudicados.

NOTA: En el caso de ejercicios en que el servicio es continuado efectuar los recambios de arriba descritos por lo menos con frecuencia semanal.

5. REGLAJES DU TECHNICIEN QUALIFIE

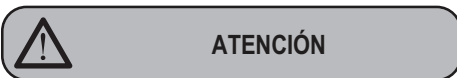

ATENCIÓN

Las regulaciones que se enumeran a continuación tienen que ser realizadas **SÓLO** por el Técnico Especializado.

La Nueva Simonelli no se hace responsable de los daños a cosas o personas si no se siguen las instrucciones de seguridad descritas en este manual.



ATENCIÓN
PELIGRO DE DESCARGA
ELÉCTRICA

Antes de efectuar cualquier operación de regulación el Técnico especializado tiene que apagar el interruptor de la máquina y desenchufar.

5.1 LLENADO MANUAL DE LA CALDERA

Todos los modelos *Appia* están provistos de sonda de nivel, para mantener constante el nivel de agua dentro de la caldera.

Se aconseja, antes de la primera puesta en funcionamiento de la máquina, llenar manualmente la caldera para evitar que la resistencia eléctrica se dañe y que se active la protección electrónica.

Si esto sucediera, bastará apagar la máquina y encenderla nuevamente, para completar la carga (véase el capítulo "MENSAJES FUNCIÓN MÁQUINA – ERROR NIVEL").

Para realizar el primer llenado manual, proceder como se describe a continuación:

- quitar la rejilla de la superficie de trabajo;

- abrir el robinete de nivel manual "A", para permitir la entrada de agua en la caldera;
- una vez alcanzado el nivel mínimo, indicado por el nivel óptico, cerrar el robinete "A";

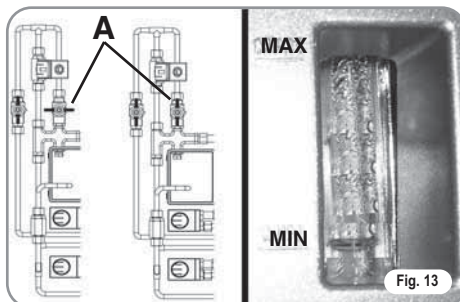

Fig. 13

- encender la máquina, llevando el interruptor general a la posición "I", de modo de activar la sonda de nivel, que realizará el mantenimiento del agua en la caldera de forma automática.

5.2 REGULACIÓN PRESOSTATO / BOMBA

Para modificar la presión de funcionamiento de la caldera, o sea la temperatura del agua, en función a las distintas exigencias o características del café utilizado, proceder como se describe a continuación:

- quitar la rejilla de la superficie de trabajo;
- quitar la protección metálica desenroscando los dos tornillos laterales (A) como se muestra en la siguiente figura;



Fig. 14

- Operar en el tornillo de regulación de la bomba para **AUMENTAR** (sentido horario) o bien **DISMINUIR** (sentido antihorario) la presión;

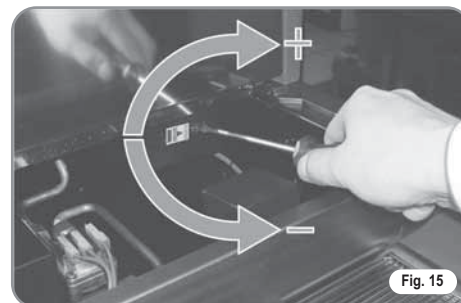

Fig. 15

Valor aconsejado: 1 - 1,4 bar
(según el tipo de café).

- Operar en el tornillo de regulación de la bomba para **AUMENTAR** (sentido horario) o bien **DISMINUIR** (sentido antihorario) la presión;

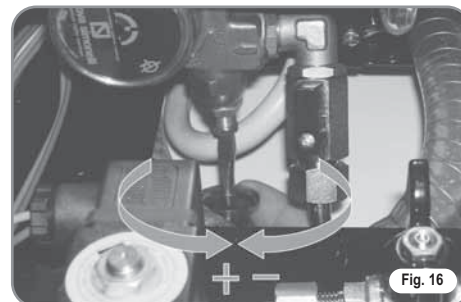
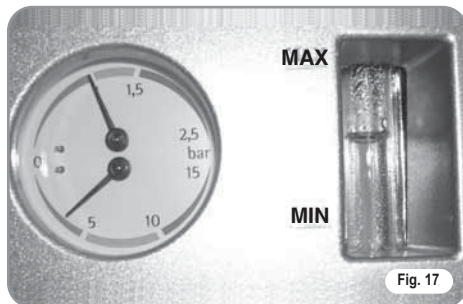

Fig. 16

Valor aconsejado: 9 bar

- La presión configurada de la bomba se visualiza en la parte inferior del manómetro.



Al finalizar las regulaciones, colocar suavemente la protección metálica en el alojamiento correspondiente y fijarla con los cuatro tornillos laterales; volver a colocar la rejilla de la superficie de trabajo.

5.3 REGULACIÓN ECONOMIZADOR AGUA CALIENTE (versión opcional /ESSE)

Todos los modelos *Appia* están equipados con un mezclador de agua caliente, que permite regular la temperatura del agua que sale y de optimizar el rendimiento del sistema.

Para regular el economizador de agua caliente hay que quitar el panel izquierdo de la máquina haciendo lo que se dice a continuación:

- desenroscar los dos tornillos superiores (Fig. 18);



- desenroscar el tornillo al lado del dispositivo vapor A;
- apretar el pomo B y quitar el panel izquierdo.

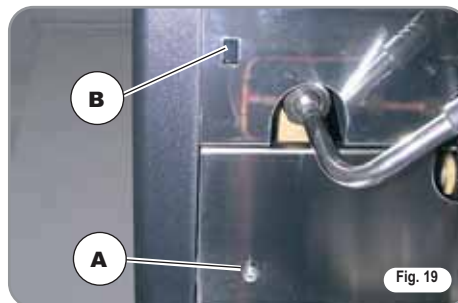

- para regular la temperatura del agua caliente de salida por el dispositivo vapor girar el pomo de registro en sentido DE LAS AGUJAS DEL RELOJ/ CONTRARIO A LAS AGUJAS DEL RELOJ para AUMENTAR / DISMINUIR la temperatura;



- al acabar la operación volver a montar el panel izquierdo de la máquina.

5.4 SUSTITUCIÓN DE LOS PULSADORES

Para un correcto funcionamiento es necesario, durante la sustitución, personalizar cada placa de los pulsadores, operando en los selectores ubicados en la placa (sector botones) como se indica debajo.

GRUPO	sw1	sw2	sw3	sw4	sw5	sw6
Grupo 1	On	Off	Off	On	Off	Off
Grupo 2	Off	On	Off	Off	On	Off
Grupo 3	Off	Off	On	Off	Off	On

6. UTILIZACIÓN

El operador, antes de comenzar la elaboración, debe asegurarse de haber leído y comprendido bien las prescripciones de seguridad de este manual.

6.1 APPIA V

6.1.1 ENCENDIDO

- conectar la máquina a la red eléctrica.
- Situar el interruptor general (n.13, Fig 1) en posición "ON".

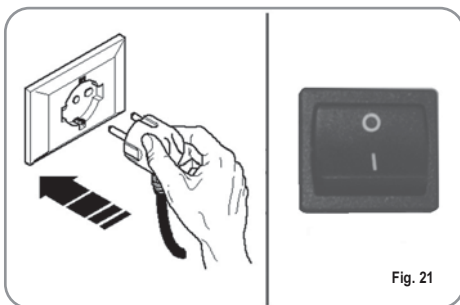





Fig. 21

El led del botón de encendido  empezará a destellar.

Mantener apretado el botón de encendido  durante 5 segundos;

entonces empezará el Lamp-test en el que todos los led están encendidos; después de 3 segundos el Lamp-test termina y se apaga el botón agua caliente .



La fase de máquina en marcha está indicada por el encendido permanente del led botón encendido  y de todos los led de los botones erogación.

NOTA: todos los botones de selección están habilitados desde el final del diagnóstico.



En caso de mantenimiento al circuito integrado electrónico apagar la máquina mediante el interruptor general externo o desconectar el cable de alimentación.

6.1.2 APAGADO

- Apretando el botón encendido/apagado  y manteniéndolo apretado durante aproximadamente 2 segundos la máquina se apaga y el led del botón encendido/apagado  vuelve a destellar.
- Poner después el interruptor general en posición "OFF".

6.2 APPIA ESSE

6.2.1 ENCENDIDO

- Conectar la máquina a la toma eléctrica y poner el interruptor general (n.13 fig 1) en posición "ON".

6.2.2 APAGADO

- Poner el interruptor general (n.13, Fig.1) en posición "OFF".

6.3 CONFIGURACIÓN DE LA SELECCIÓN

Configurar la función deseada en los botones a disposición ubicados sobre los portafiltros (Véase el capítulo "DESCRIPCIÓN").



Fig. 22

LEYENDA BOTONES (Configuración selecciones)



1 Café corto



2 Café corto



1 Café largo



2 Café largo



Continuo

6.4 PREPARACIÓN DEL CAFÉ

Desenganchar el portafiltro y llenar con una o dos dosis de café molido según el filtro utilizado.

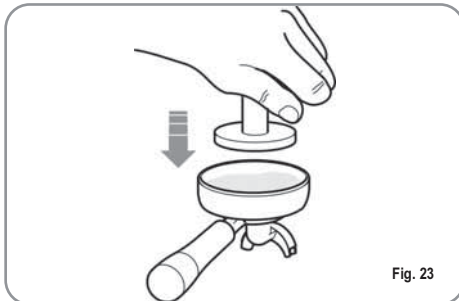

Fig. 23

Presionar el café con la prensa del equipamiento, limpiar los restos de polvo de café del borde periférico del filtro (para garantizar un mejor cierre y un menor desgaste de la junta). Luego acoplar el portafiltro en el grupo. Presionar el pulsador del café deseado:



1 Café corto



2 Café corto



1 Café largo



2 Café largo

Se activa la bomba y se abre la electroválvula del grupo dando inicio a la infusión del café. La operación se evidencia por el encendido del botón presionado.

NOTA: en las fases de pausa, dejar el portafiltro acoplado al grupo para que permanezca siempre caliente.

Los grupos de erogación son compensados térmicamente con circulación total de agua caliente, para garantizar

la máxima estabilidad térmica durante el funcionamiento.

6.5 UTILIZACIÓN DEL VAPOR



ATENCIÓN
PELIGRO DE QUEMADURAS

Durante el uso de la lanza del vapor, prestar mucha atención a no colocar las manos debajo de la misma y a no tocarla enseguida luego de su uso.

Para utilizar el vapor basta tirar o empujar la palanca correspondiente (Fig. 24).

Si se la tira completamente, la palanca permanece bloqueada en la posición de máxima erogación, si se la empuja, el retorno de la palanca es automático.

Las dos palancas lanza vapor son articuladas, para que su utilización sea más fácil.



Fig. 24

NOTA: El empleo del lanzador vapor tiene que ser siempre precedido por la operación de purga de la condensación durante al menos 2 segundos o siguiendo las instrucciones del fabricante.

6.6 PREPARACIÓN DEL CAPPUCINO

Para obtener la típica espuma sumergir el pico del vapor en el fondo del recipiente lleno por 1/3 (preferiblemente en forma tronco-cónico).

Abir el vapor. Antes que la leche llegue al punto de ebullición, llevar el pico del vapor hasta la superficie haciendo descremar la leche con pequeños desplazamientos en sentido vertical. Al final de la operación limpiar cuidadosamente la lanza con un paño suave.

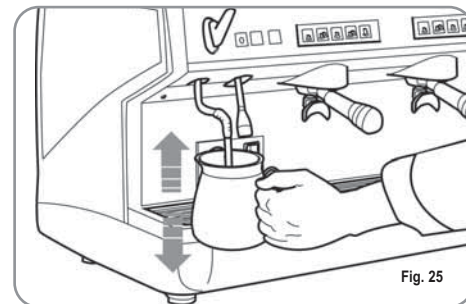

Fig. 25

6.7 SELECCIÓN DE AGUA CALIENTE



ATENCIÓN
PELIGRO DE QUEMADURAS

Durante el uso de la lanza del vapor, prestar mucha atención a no colocar las manos debajo de la misma y a no tocarla enseguida luego de su uso.

Permite la erogación de agua caliente para preparar té, manzanilla y tisanas.

Situar debajo del lanzador de agua caliente un recipiente y accionar el interruptor (versión ESSE) o apretar el pulsante selección agua caliente  (versión V).

Asegurarse de que dicho pulsador se ilumine. La lanza de agua caliente erogará agua durante el tiempo programado.

NOTA: La erogación del agua caliente se puede producir al mismo tiempo que la del café

7. PROGRAMACIÓN Appia V

7.1 PROGRAMMACION DOSIS

Para entrar en el ámbito de la programación, operar como se describe a continuación:

NOTA: operación que se debe realizar con la máquina encendida.

- Para entrar en la fase de programación dosis de cada grupo hay que apretar durante 5 segundos el botón erogación continua



- Los botones erogación empezarán a destellar.
- El acceso a la programación del primer grupo habilita también el ajuste de los parámetros de funcionamiento de la máquina.

7.2 PROGRAMACIÓN DOSIS CAFÉS

Para programar la dosis de agua relativa a uno de los botones erogación, proceder como se dice a continuación:

- llenar con la dosis adecuada de café el portafiltro (el portafiltro puede ser sencillo o doble, según el botón que se desee programar).
- Poner el portafiltro en el grupo.
- Apretar uno de los pulsantes erogadores:



- Empieza la erogación; una vez se alcance la cantidad deseada apretar el botón continuo



- La erogación acaba y el botón dosis elegido se apaga (los otros botones continúan destelleando).



- Apretar el botón continuo para salir de la programación o continuar la programación de los otros botones dosis.

NOTA: Este procedimiento se puede emplear para todos los grupos de la máquina excepto si se efectúa un grupo cada vez, los otros grupos pueden continuar trabajando normalmente.

7.3 PROGRAMACIÓN AGUA CALIENTE

- Entrar en programación según el procedimiento correspondiente.
- Apretar el botón selección agua caliente



- Empieza la erogación del agua caliente.
- Establecer la dosis de agua caliente deseada y apretar de nuevo el botón



- Apretar el botón continuo para salir de la programación o continuar la programación de otros botones selección.



- Los botones erogación del primer y segundo grupo señalan respectivamente el tiempo de encendido y de apagado en el modo automático mientras están intermitentes los botones continuo del primer y del segundo grupo.



Como se describe en la tabla, a cada uno de los botones erogación hay asociado un valor; el tiempo de encendido del calienta-tazas lo da la suma de los valores de los botones del primer grupo iluminados. El mismo modo de recuento se da para el tiempo de apagado del calienta-tazas con los botones del segundo grupo.

Botón	Grupo 1 (tiempo on)	Grupo 2 (tiempo off)
	2 min.	5 min.
	4 min.	10 min.
	8 min.	20 min.
	16 min.	40 min.

7.4 PROGRAMACIÓN CALIENTA-TAZAS (opcional)

- Entrer dans la page de programmation du premier groupe selon la procédure relative.
- Frapper la touche de sélection chauffe-tasses



7.5 PROGRAMACIÓN DOSIS ESTÁNDAR

- Es posible programar valores predeterminados para las 4 dosis del grupo, para el agua (vapor).

Para hacer esto hay que apretar el botón  y mantenerlo apretado durante

al menos 10 segundos hasta que los botones intermitentes se apaguen. Las dosis son:

1CN	2CN	1CL	2CL
40 cc	60 cc	50 cc	85 cc

AGUA
9 sec.

NOTA: Un tiempo de 0 segundos para el agua y para el vapor determina el funcionamiento continuo.

7.6 COPIAR DOSIS

Se pueden copiar las dosis memorizadas para el grupo 1 en las dosis del grupo 2 ó 3.



Esta operación se realiza apretando el botón continuo 

del grupo 2 ó 3 por lo menos durante 8 segundos hasta que los botones intermitentes se apaguen.

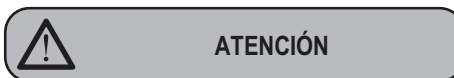
7.7 PROGRAMACIÓN PARÁMETROS DE FUNCIONAMIENTO





Las regulaciones que se enumeran a continuación tienen que ser realizadas **SÓLO** por el Técnico Especializado.

Apretando el botón  del segundo grupo, después de haber entrado en programación del primer grupo, se accede al ajuste de los parámetros de funcionamiento máquina; situación señalada por el encendido del botón continuo del segundo grupo .

1. Accionamiento bomba si está activado el nivel.
2. Accionamiento bloque software para la entrada en programación dosis.
3. Regulación luminosidad teclado.
4. Accionamiento bomba con agua caliente (en las máquinas).
5. Deshabilitación calienta-tazas.
6. Restablecimiento parámetros predefinidos.

1. Accionamiento bomba durante nivel.

Trámite el botón café corto  del segundo grupo se ajusta la activación de la bomba durante el nivel:

si el botón  está encendido la bomba se acciona junto al nivel, si está apagado la bomba no se acciona con el nivel.

2. Accionamiento bloque software para entrar en programación dosis.

Mediante el botón café largo  se acciona el bloque software para la programación de las dosis (botón encendido) o se desactiva el bloque (botón apagado).

3. Regulación luminosidad teclado.

El botón 2 cafés largos  del segundo grupo se utiliza para elegir la luminosidad de los botones entre 5 niveles preestablecidos.

Apretando el botón , intermitente, se cambia el nivel, bajando el valor hasta el mínimo para después volver al valor máximo.

4. Accionamiento bomba con agua caliente (sólo para máquinas con economizador).

Mediante el botón agua caliente  se establece la activación de la bomba durante la erogación de agua.

Si el botón  está encendido la bomba se activa durante la erogación de agua caliente, si está apagado la bomba no se acciona.

5. Deshabilitación calienta-tazas.

Mediante el botón  se activa o se desactiva el funcionamiento del calienta-tazas; si el botón está encendido el calienta-tazas funciona normalmente como ha sido establecido en la programación, si el botón está apagado el calienta-tazas está deshabilitado.

Si el caliente-tazas no está habilitado el botón  se enciende sólo durante el

Lamp-test, después de esto, cada vez que apretemos el botón no tendrá ningún efecto.

Apertando el botón continuo  del segundo grupo se memorizan los valores modificados y se sale de la página para ajustar los parámetros del funcionamiento de la máquina.

6. Restablecimiento de los parámetros predefinidos



Se pueden restablecer los parámetros predefinidos, es decir, nivel bomba, agua con bomba, luz máxima y caliente-tazas habilitado.



Para restablecer estos parámetros es suficiente encender la máquina mediante el botón , con los botones 2 cafés cortos y

 dos cafés largos  del primer grupo apretados contemporáneamente.

7.8 CICLO AUTOMÁTICO DE LIMPIEZA GRUPOS

Para entrar en la fase de limpieza automática hay que apagar la máquina y volver a encenderla manteniendo apretados los botones agua



caliente  y caliente-tazas  durante el Lamp-test inicial.

Cuando acaba el Lamp-test empiezan a destellar los botones  y  y los boto-

nes un café largo  de todos los grupos.



Apertando el botón  empieza el ciclo de lavado del grupo correspondiente.

Acabado el ciclo de lavado se puede efectuar el ciclo de aclarado del mismo grupo, apertando de nuevo el botón .

Si se quiere realizar el ciclo de aclarado en otro momento es suficiente apagar la máquina: el circuito integrado mantiene memorizados los ciclos de limpieza por terminar. Con el sucesivo encendido el circuito entrará automáticamente en la fase de limpieza grupos, sin tener que apertar los botones  y .

Apertando los botones  y  durante dos segundos salimos de la fase de limpieza en el caso en que no haya ciclos por terminar, si no permanecerán intermitentes los botones

 de los grupos en los que se tenga todavía que realizar el ciclo de aclarado.

Manteniendo los botones  y  durante otros dos segundos, se fuerza la salida de la fase de limpieza poniendo a cero la información de los aclarados por terminar.

Si el ciclo de limpieza se completa, el botón  del grupo se apaga.

Si no hay que realizar más aclarados el circuito integrado sale de la fase de limpieza.

8. LIMPIEZA Y MANTENIMIENTO

Durante el mantenimiento/repación los componentes utilizados tienen que garantizar mantener los requisitos de higiene y seguridad previstos por el dispositivo. Los recambios originales dan esta garantía.

Después de una reparación o una sustitución de componentes que afectan partes en contacto con agua y alimentos, se tiene que efectuar el procedimiento de lavado o siguiendo los procedimientos indicados por el fabricante.

8.1 DETENCIÓN

Para parar la máquina hay que volver a apretar el interruptor general y llevarlo a la posición OFF.



Fig. 26

8.2 LIMPIEZA EXTERIOR

Antes de efectuar cualquier operación de limpieza, hay que llevar la máquina a estado energético "0" (es decir, interruptor máquina apagado y seccionador abierto).



ATENCIÓN

No utilizar solventes, productos a base de cloro, abrasivos.

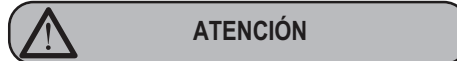

ATENCIÓN

No se puede limpiar el aparato con chorro de agua o sumergiéndolo en agua.

Limpieza de la zona trabajo: quitar la rejilla de la superficie de trabajo levantándola primero hacia arriba y retirarla, quitar el plato para recoger el agua ubicado debajo y limpiar todo con agua caliente y detergente. **Limpieza de la carena:** para limpiar todas las partes cromadas utilizar un paño suave humedecido.

8.3 LIMPIEZA DE LAS ROSETAS INOXIDABLES

Las rosetas inoxidables están ubicadas debajo de los grupos de erogación, como se observa en la figura. 27.



Fig. 27

NOTA: Para la limpieza operar como se describe a continuación:

- Desenroscar el tornillo ubicado en el centro de la roseta.
- Quitar la roseta y controlar que los orificios no estén obstruidos.
- En caso de obstrucciones, limpiar según la descripción (Apartado "LIMPIEZA DE LOS FILTROS Y PORTAFILTROS").

Se recomienda limpiar la roseta semanalmente.

8.4 LIMPIEZA DEL GRUPO CON LA AYUDA DEL FILTRO CIEGO

La máquina está dispuesta para el lavado del grupo de erogación con detergente en polvo específico.

Se aconseja realizar el lavado al menos una vez al día con los detergentes apropiados.



ATENCIÓN PELIGRO DE INTOXICACIÓN

Una vez quitado el portafiltro realizar algunas erogaciones para eliminar eventuales restos de detergente.

Para realizar el procedimiento de lavado proceder como se indica a continuación:

- 1) Sustituir el filtro con el filtro ciego del grupo de erogación.
- 2) Colocar en el interior dos cucharadas de detergente en polvo específico e introducir el portafiltro en el grupo.
- 3) Presionar uno de los botones de café y detener luego de 10 seg. .
- 4) Repetir la operación varias veces.
- 5) Quitar el portafiltro y realizar algunas erogaciones.

8.5 LIMPIEZA DE LOS FILTROS Y PORTAFILTROS

Colocar dos cucharadas de detergente específico en medio litro de agua caliente e introducir el filtro y el portafiltro (excluido el mango) durante al menos media hora. Luego enjuagar con abundante agua corriente.

8.6 REGENERACIÓN DE LAS RESINAS DEL ENDULZANTER

Con el fin de evitar la formación de depósitos de sarro dentro de la caldera y de los intercambiadores de calor es necesario que el endulzante esté siempre en perfecto estado. Para ello es necesario realizar regularmente la regeneración de las resinas iónicas.

Los tiempos de regeneración se deben establecer en función a la cantidad de café erogada diariamente y a la dureza del agua utilizada. Como orientación se pueden apreciar en el diagrama reproducido en la Fig. 28.

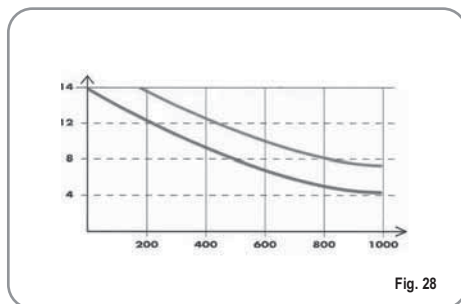

Los procedimientos de regeneración son los siguientes:

1) Apagar la máquina y colocar un recipiente de al menos 5 litros de capacidad debajo del tubo E (Fig. 29).

Girar las palancas C y D de izquierda a derecha; quitar el tapón desenroscando el pomo G e introducir 1 Kg de sal gruesa para cocina (Fig. 30).

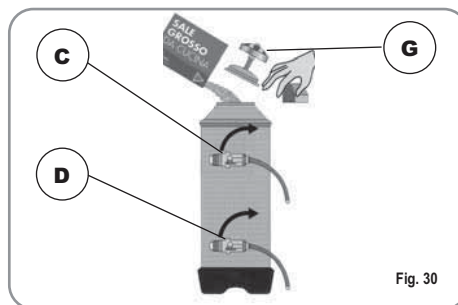
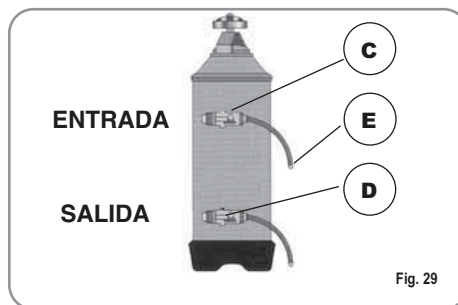

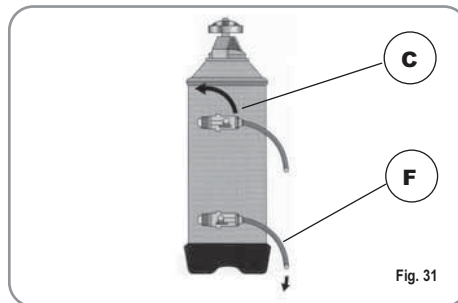

2) Colocar nuevamente el tapón y llevar la palanca C hacia la izquierda (Fig. 31), dejando descargar el agua salada del tubo F para que no se vuelva dulce aproximadamente 1/2 hora).

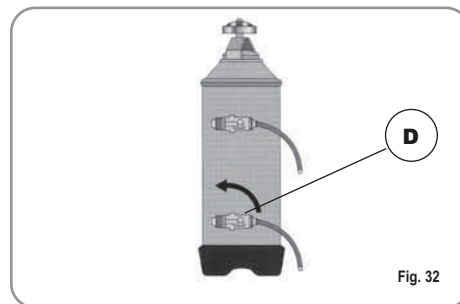

3) Llevar nuevamente la palanca D hacia la izquierda (Fig. 32).



9. MENSAJES FUNCIONES MÁQUINA Appia V

INDICACIONES DISPLAY Y BOTONES	CAUSA	EFECTO	SOLUCIÓN	NOTA
<p>Dibujo botón continuo intermi- tente y botón erogación fijo.</p>  	<p>Si dentro de los tres primeros segundos desde el inicio de la erogación, el dosificador no envió los impulsos programados.</p>	<p>Si la erogación no se interrumpe manualmente se llega al bloqueo de tiempo límite (120 seg.).</p>	<p>Interrumpir la erogación.</p>	
<p>Dibujo botón continuo intermitente.</p> 	<p>Si luego de los 90 seg. desde el inicio, con bomba accionada durante la autonivelación, a 180 seg. se deshabilita, el nivel no ha sido restablecido.</p>	<p>Se desactiva la bomba, la resistencia y todas las funciones se inhiben.</p>	<p>Apagar la máquina durante al menos 5 seg. Y encenderla nuevamente.</p>	

Appia[®]
MADE IN ITALY

INSTALLATION ELECTRIQUE / ALEKTRISCHE ANLAGE / INSTALACIÓN ELÉCTRICA Appia ESSE 2/3 GR.

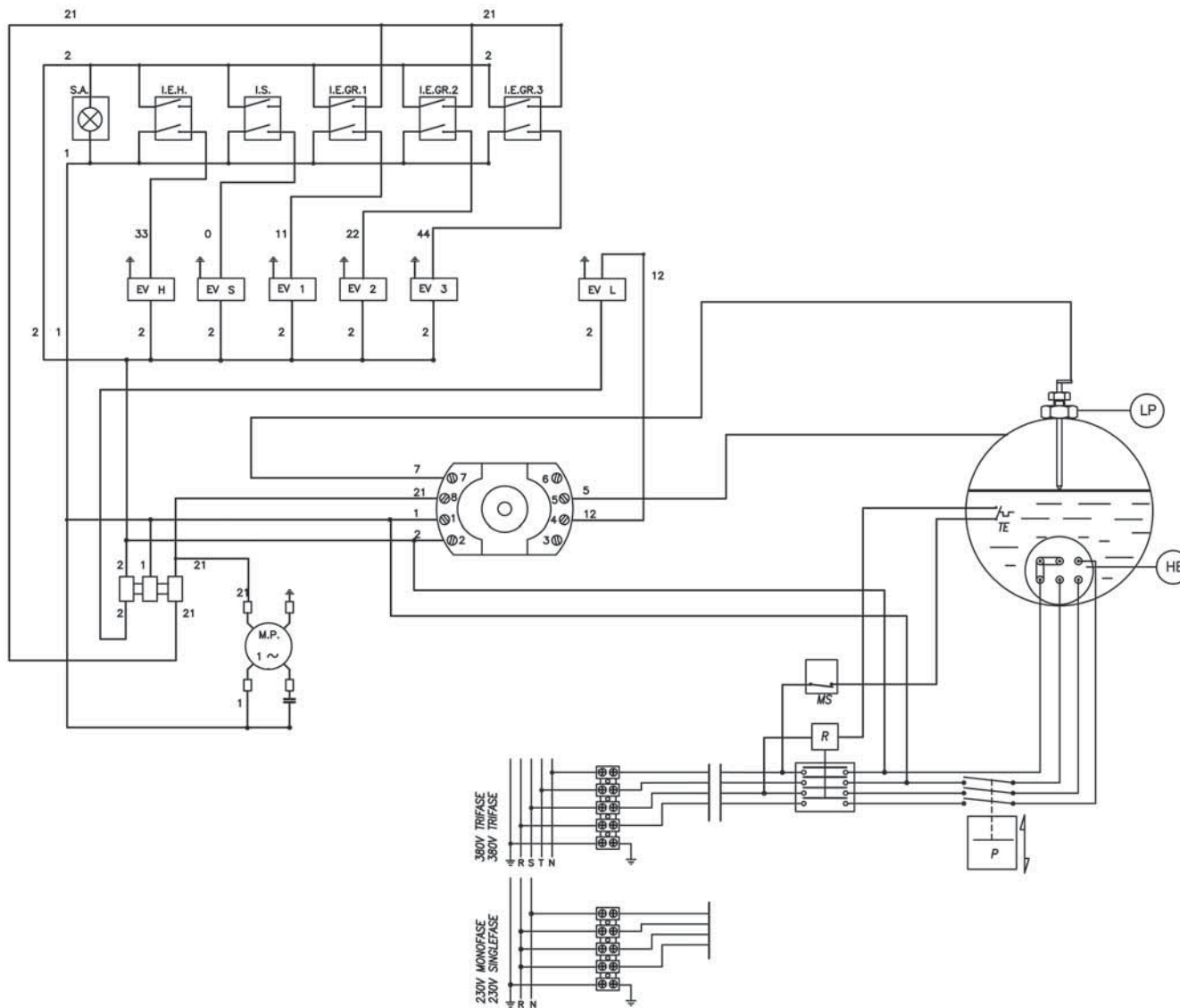

Fig. 33

INSTALLATION ELECTRIQUE /ALEKTRISCHE ANLAGE / INSTALACIÓN ELÉCTRICA *Appia ESSE 2/3 GR.*

LÉGENDE	ZEICHENERKLÄRUNG	NOTA
EV H Electrovanne vapeur / eau chaude	EV H Elektroventil Dampf / Heißwasser	EV H Electroválvula vapor / agua caliente
EV S Electrovanne chauffe-tas- ses	EV S Elektroventil Tassenwärmer	EV S Electroválvula calienta- tazas
EV1-2-3 Electrovanne de distribu- tion groupe	EV1-2-3 E l e k t r o v e n t i l Gruppenausgabe	EV1-2-3 Electroválvula erogación grupo
MP Moteur pompe	MP Pumpenmotor	MP Motor bomba
I.S Interrupteur chauffe-tasses	I.S Schalter Tassenwärmer	I.S Interruptor calienta-tazas
I.E.H. Interrupteur eau chaude	I.E.H. Schalter Heißwasser	I.E.H. Interruptor agua caliente
I.E.GR.1-2-3 Interrupteur groupe 1-2-3	I.E.GR.1-2-3 Schalter Gruppe 1-2-3	I.E.GR.1-2-3 Interruptor grupo 1-2-3
R Relais	R Relais	R Relé
P Pressostat	P Druckwächter	P Pressostato
EV L Electrovanne de niveau	EV L Elektroventil Füllstand	EV L Electroválvula nivel
MS Interrupteur général	MS Hauptschalter	MS Interruptor general
HE Résistance	HE Widerstand	HE Resistencia
LP Sonde niveau	LP Füllstandsonde	LP Sonda nivel
TE Thermostat de sécurité	TE Sicherheitsthermostat	TE Termostato seguridad
S.A. lampe témoin	S.A. Kontrollleuchte	S.A. Luz indicadora piloto

INSTALLATION ELECTRIQUE / ALEKTRISCHE ANLAGE / INSTALACIÓN ELÉCTRICA Appia V 2 GR.

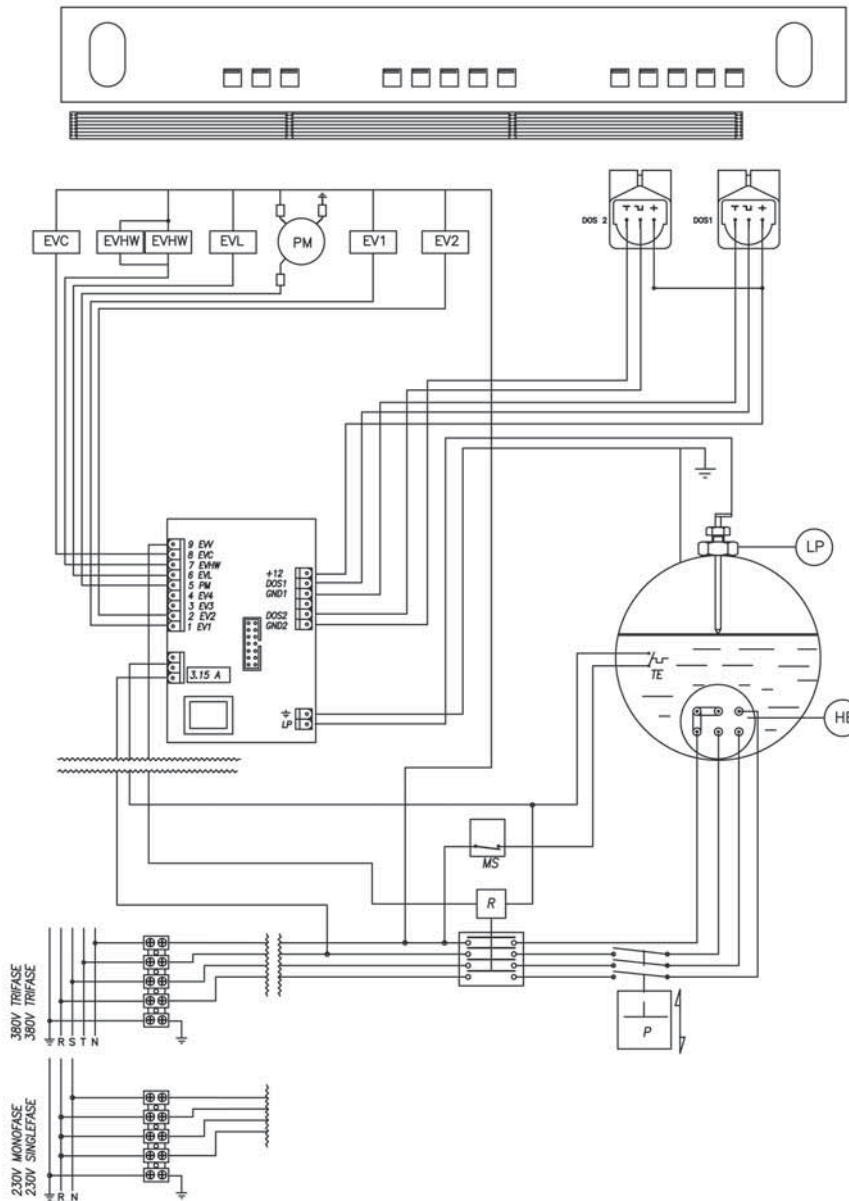

Fig. 34

INSTALLATION ELECTRIQUE /ALEKTRISCHE ANLAGE / INSTALACIÓN ELÉCTRICA Appia V 2 GR.

LÉGENDE

EVC
 Electrovanne chauffe-tasses

EVHW
 Electrovanne mélangeur eau chaude

EV L
 Electrovanne de niveau

EV1-2-3
 Electrovanne de distribution groupe

PM
 Moteur pompe

Dose
 Ventilateur

HE
 Résistance

LP
 Sonde niveau

TE
 Thermostat de sécurité

R
 Relais

P
 Pressostat

MS
 Interrupteur général

TP
 Sonde température

ZEICHENERKLÄRUNG

EVC
 Elektroventil Tassenwärmer

EVHW
 Elektroventil Heißwassermischer

EV L
 Elektroventil Füllstand

EV1-2-3
 Elektroventil Gruppenausgabe

PM
 Pumpenmotor

Dosis
 Gebläse

HE
 Widerstand

LP
 Füllstandsonde

TE
 Sicherheitsthermostat

R
 Relais

P
 Druckwächter

MS
 Hauptschalter

TP
 Temperatursonde

NOTA

EVC
 Electroválvula calienta-tazas

EVHW
 Electroválvula mezclador agua caliente

EV L
 Electroválvula nivel

EV1-2-3
 Electroválvula erogación grupo

PM
 Motor bomba

Dosis
 Ventilador

HE
 Resistencia

LP
 Sonda nivel

TE
 Termostato seguridad

R
 Relè

P
 Presostato

MS
 Interruptor general

TP
 Sonda temperatura

INSTALLATION ELECTRIQUE /ALEKTRISCHE ANLAGE / INSTALACIÓN ELÉCTRICA Appia V 3 GR.

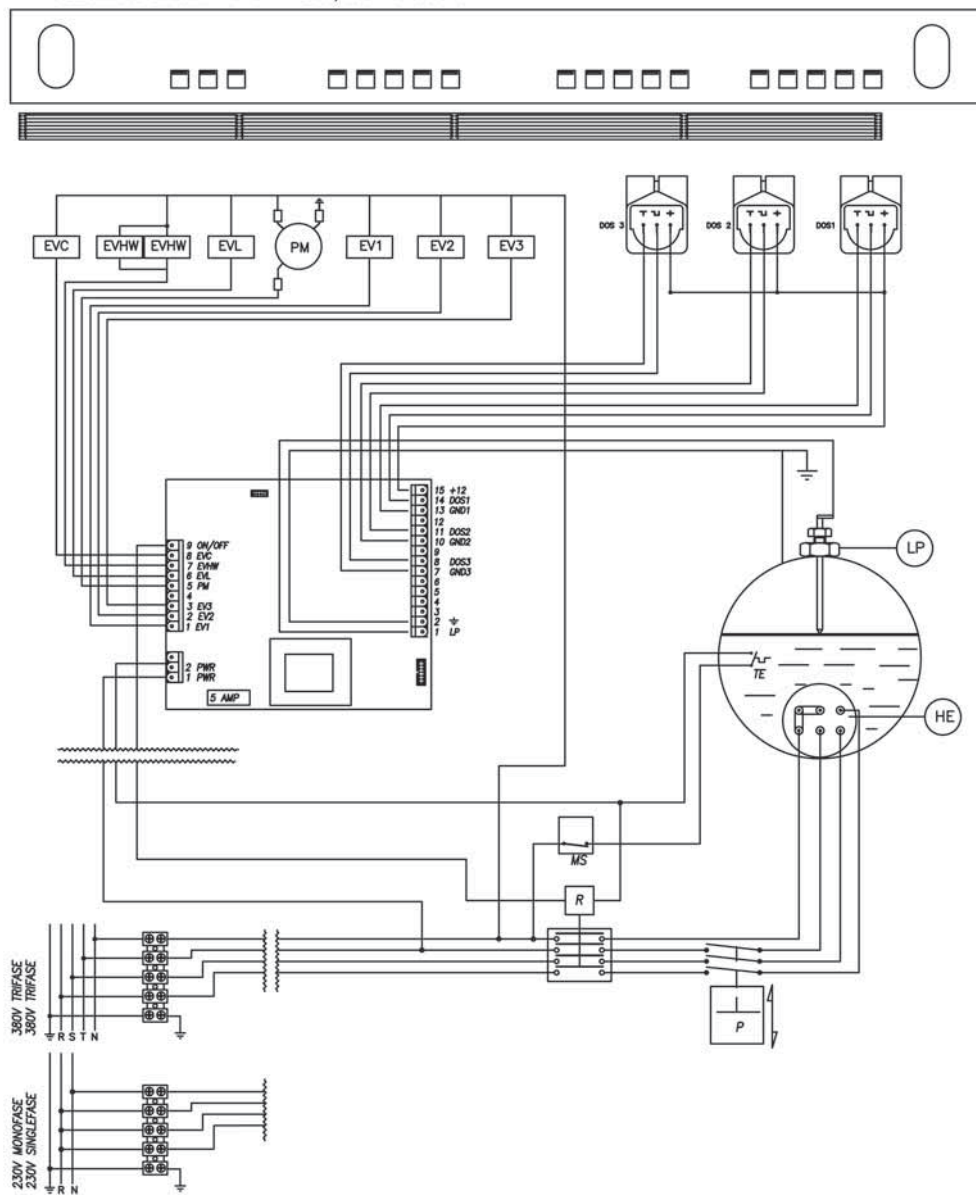

Fig. 35

INSTALLATION ELECTRIQUE /ALEKTRISCHE ANLAGE / INSTALACIÓN ELÉCTRICA Appia V 3 GR.

LÉGENDE	ZEICHENERKLÄRUNG	NOTA
EVC Electrovanne chauffe-tasses	EVC Elektroventil Tassenwärmer	EVC Electroválvula calienta-tazas
EVHW Electrovanne mélangeur eau chaude	EVHW Elektroventil Heißwassermischer	EVHW Electroválvula mezclador agua caliente
EV L Electrovanne de niveau	EV L Elektroventil Füllstand	EV L Electroválvula nivel
EV1-2-3 Electrovanne de distribution groupe	EV1-2-3 Elektroventil Gruppenausgabe	EV1-2-3 Electroválvula erogación grupo
PM Moteur pompe	PM Pumpenmotor	PM Motor bomba
Dose Ventilateur	Dosis Gebläse	Dosis Ventilador
HE Résistance	HE Widerstand	HE Resistenza
LP Sonde niveau	LP Füllstandsonde	LP Sonda nivel
TE Thermostat de sécurité	TE Sicherheitsthermostat	TE Termostato seguridad
R Relais	R Relais	R Relè
P Pressostat	P Druckwächter	P Presostato
MS Interrupteur général	MS Hauptschalter	MS Interruptor general
TP Sonde température	TP Temperatursonde	TP Sonda temperatura

INSTALLATION HYDRAULIQUE / HYDRAULIKANLAGE / INSTLACIÓN HIDRÁULICA

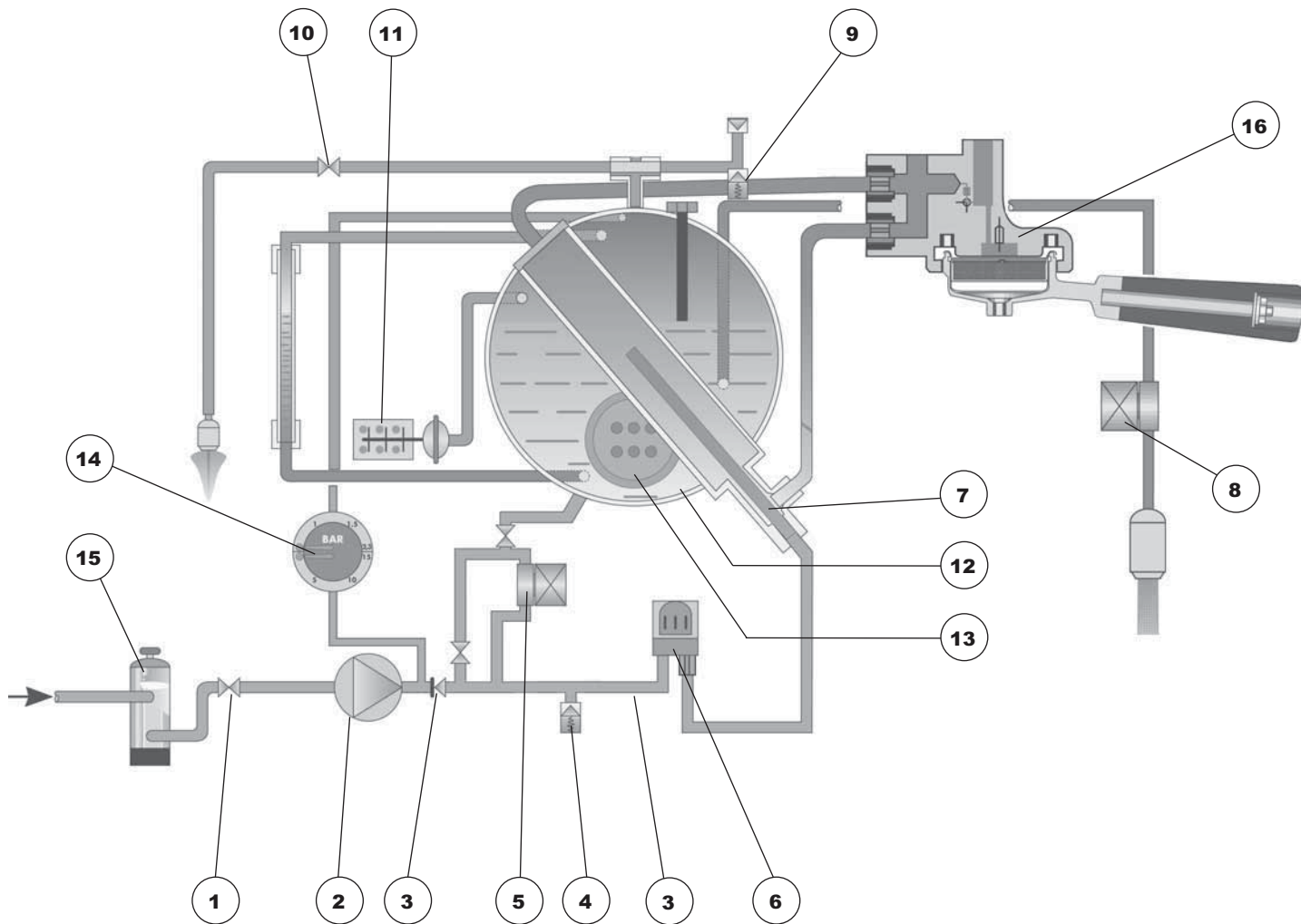

Fig. 36

INSTALLATION HYDRAULIQUE /HYDRAULIKANLAGE / INSTALCIÓN HIDRÁULICA

LÉGENDE

- 1 Robinet arrivée d'eau
- 2 Pompe
- 3 Soupape d'arrêt
- 4 Soupape d'expansion
- 5 Electrovanne de niveau
- 6 Doseur volumétrique
- 7 Echangeur de chaleur
- 8 Electrovanne de distribution
- 9 Soupape de sûreté chaudière
- 10 Robinet vapeur
- 11 Pressostat
- 12 Chaudière
- 13 Résistance
- 14 Manomètre double échelle
- 15 Dépurateur
- 16 Groupe de distribution

ZEICHENERKLÄRUNG

- 1 Hahn Wassereinlauf
- 2 Pumpe
- 3 Rückschlagventil
- 4 Drosselventil
- 5 Elektroventil Füllstand
- 6 Volumendosierer
- 7 Wärmetauscher
- 8 Elektroventil Ausgabe
- 9 Sicherheitsventil Wärmet.
- 10 Dampfhahn
- 11 Druckwächter
- 12 Kessel
- 13 Widerstand
- 14 D r u c k m e s s e r Doppelskala
- 15 Reiniger
- 16 Ausgabegruppe

NOTA

- 1 Grifo entrada agua
- 2 Bomba
- 3 Válvula de retención
- 4 Válvula de expansión
- 5 Electroválvula de nivel
- 6 Dosador volumétrico
- 7 intercambiador de calor
- 8 electroválvula de erogación
- 9 Válvula de seguridad caldera
- 10 Grifo vapor
- 11 Presostato
- 12 Caldera
- 13 Resistencia
- 14 Manómetro doble escala
- 15 Depurador
- 16 Grupo erogador

NOTE / NOTES:

A series of horizontal dashed lines for writing notes.



Nuova Distribution Centre
LLC 6940Salashan PKWY BLDG A 98248
Ferdale, WA
Tel. +1.360.3662226
Fax +1.3603664015
videoconf.+1.360.3188595
www.nuovasilmonelli.it
info@nuovasilmonelli.com



Via M. d'Antegiano, 6
62020 Belforte del Chienti
Macerata Italy
Tel. +39.0733.9501
Fax +39.0733-950242
www.nuovasilmonelli.it
E-mail: n.simonelli@nuovasilmonelli.it