

















Register your product and get support at
www.philips.com/welcome

FC6402,FC6401,FC6400



PHILIPS

	2		8
	3		9
	4		10
	4		11
	5		12
	5		13
	6		13
	7		14

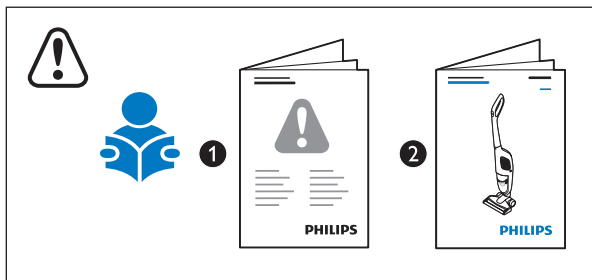

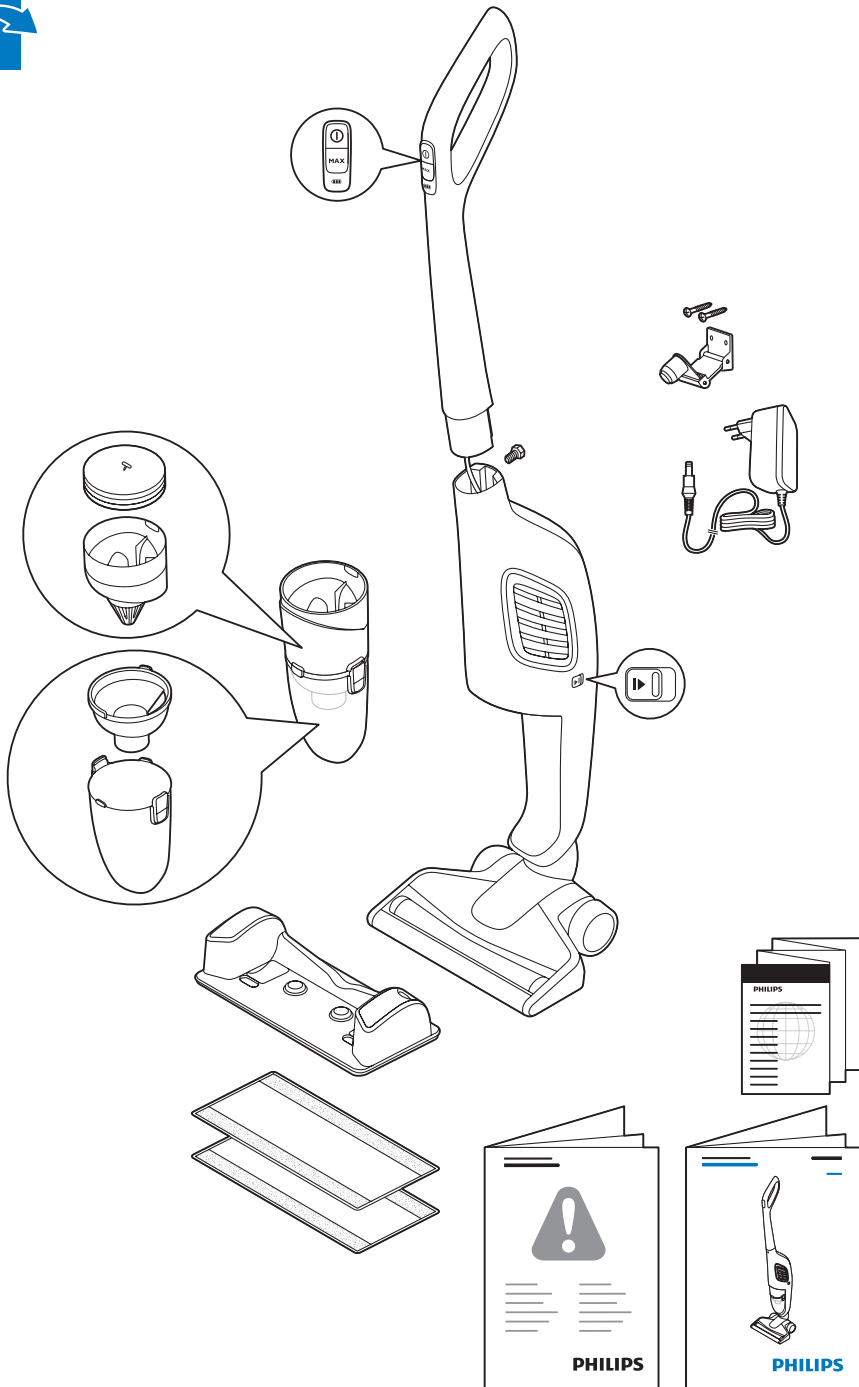

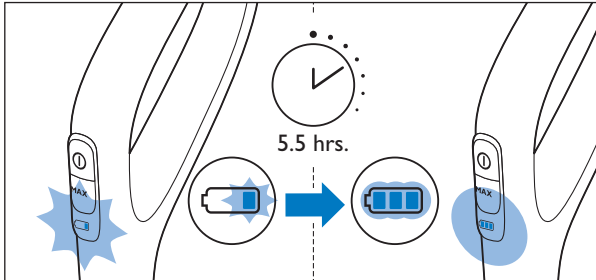
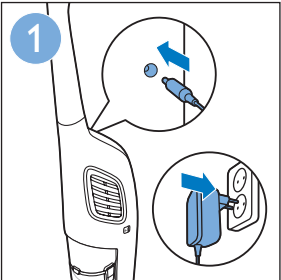
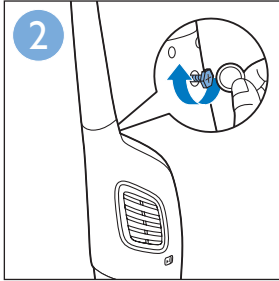
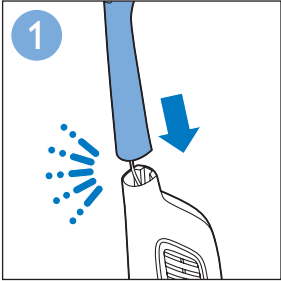

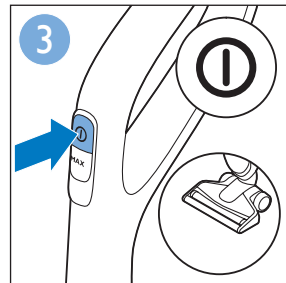
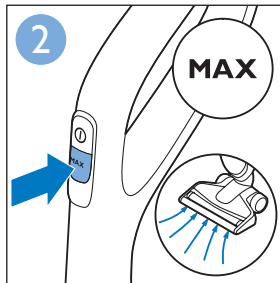
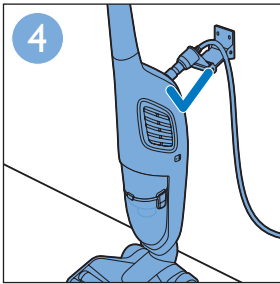
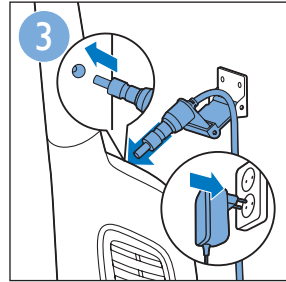
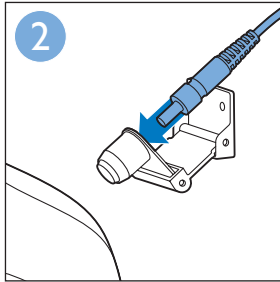
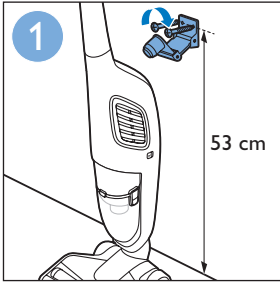

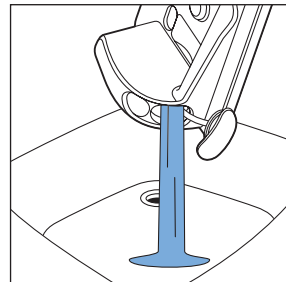
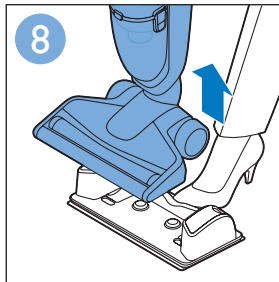
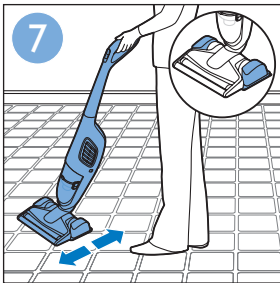
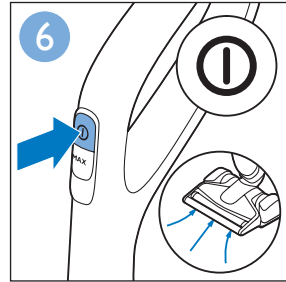
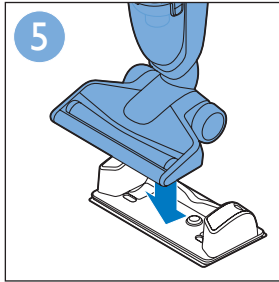
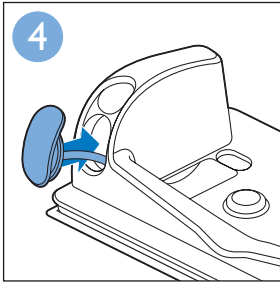
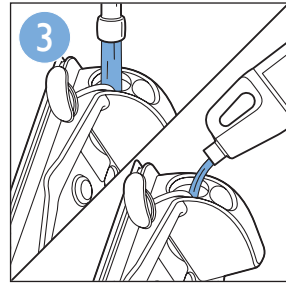
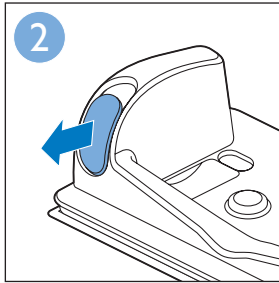
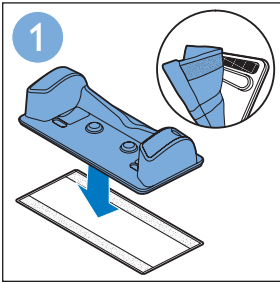

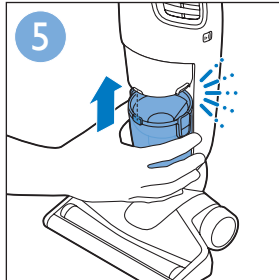
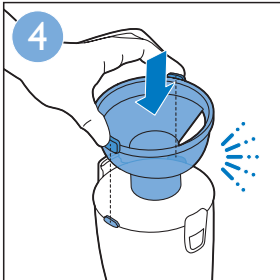
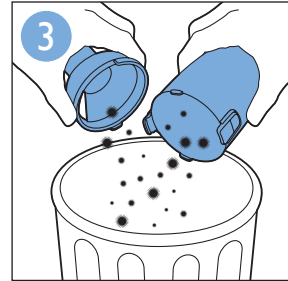
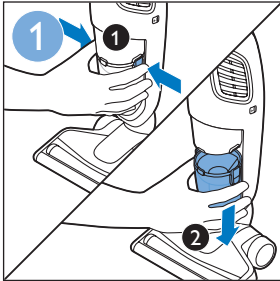

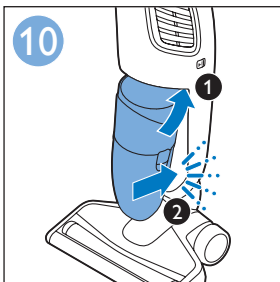
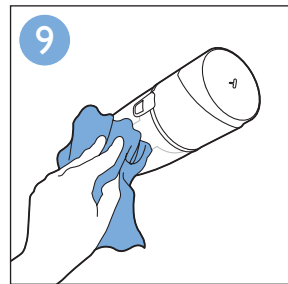
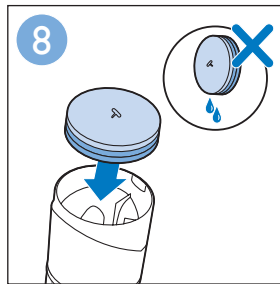
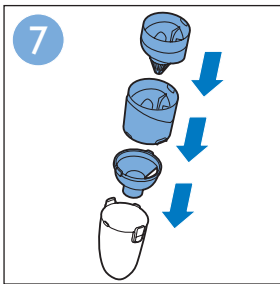
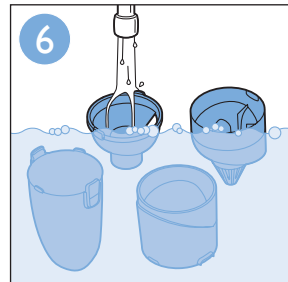
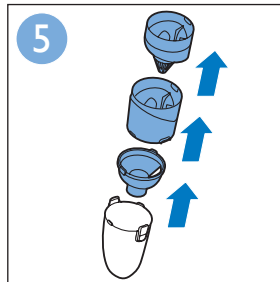
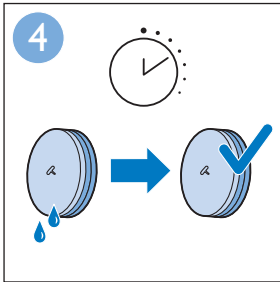
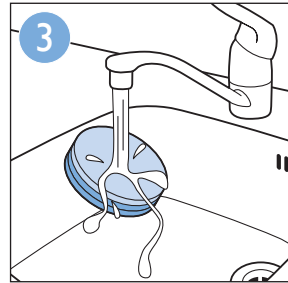
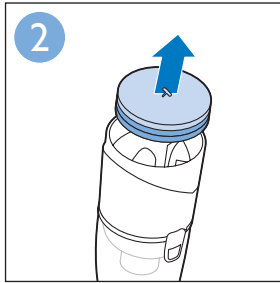
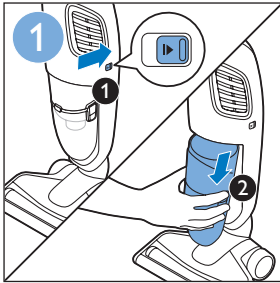

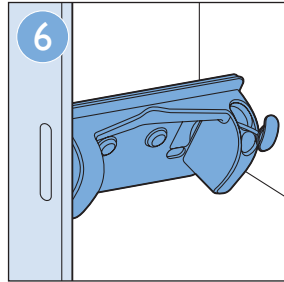
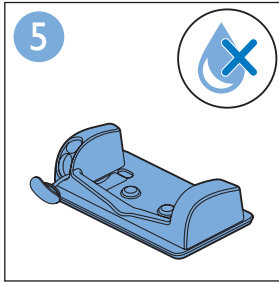
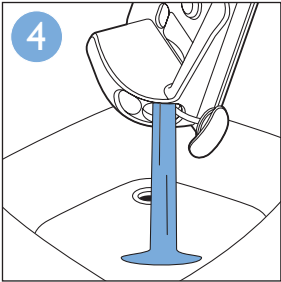
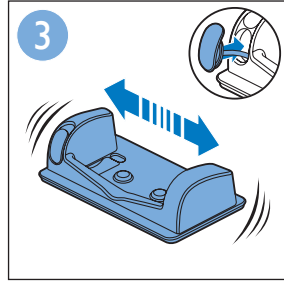
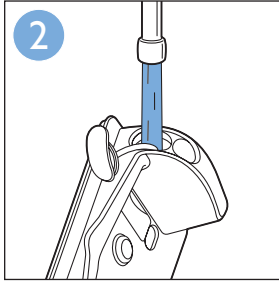
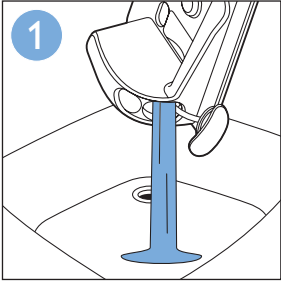

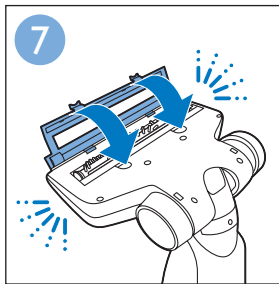
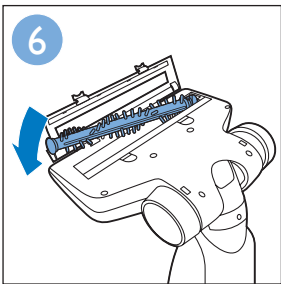
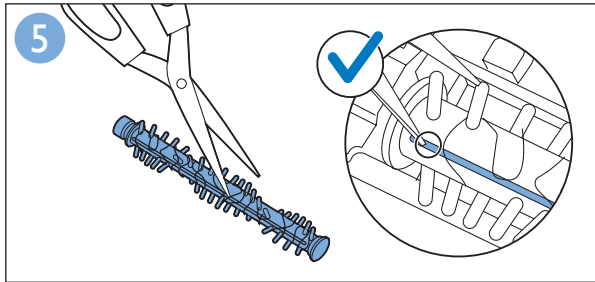
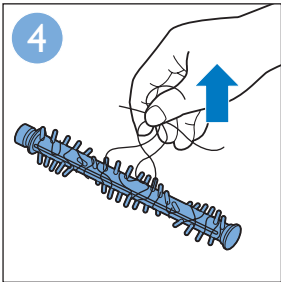
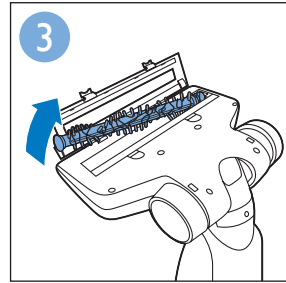
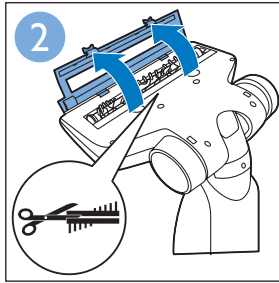
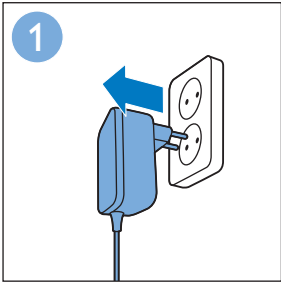

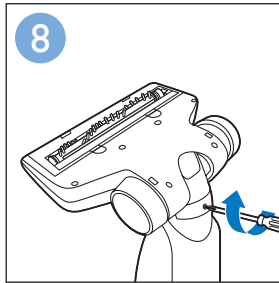
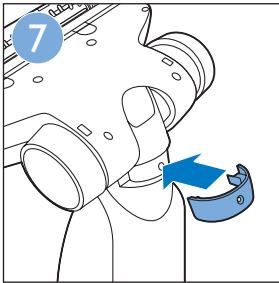
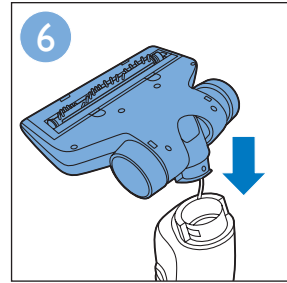
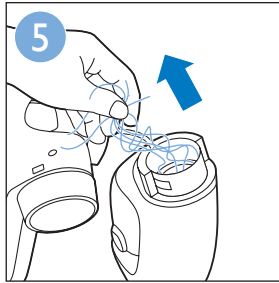
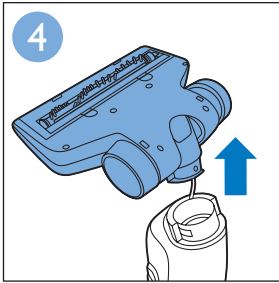
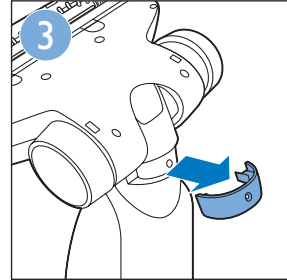
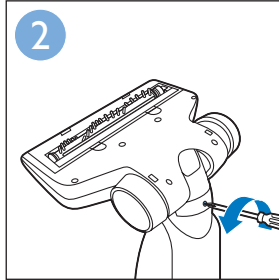
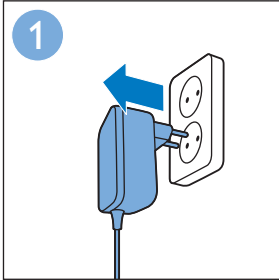

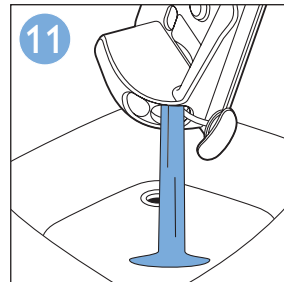
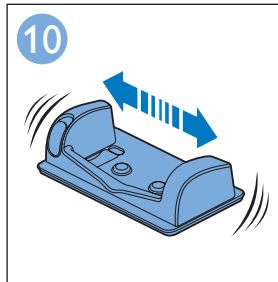
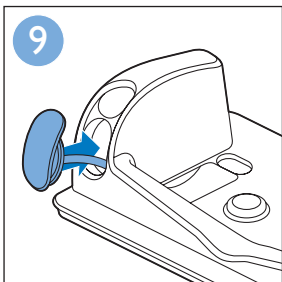
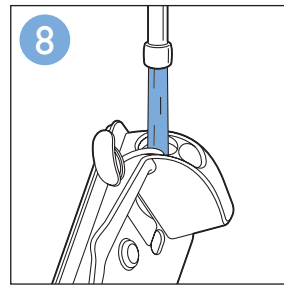
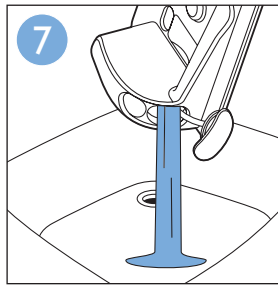
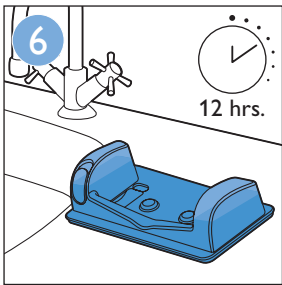
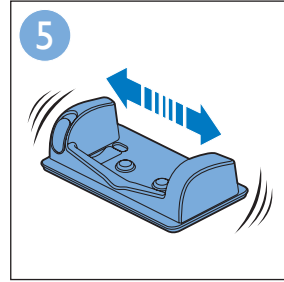
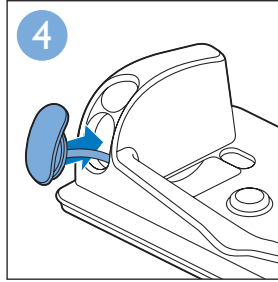
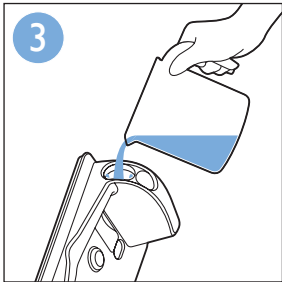
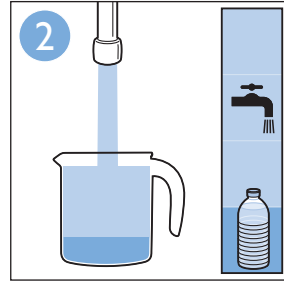
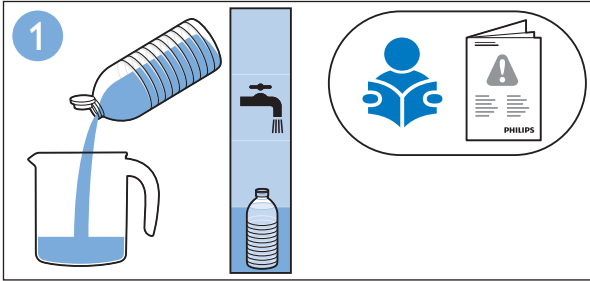

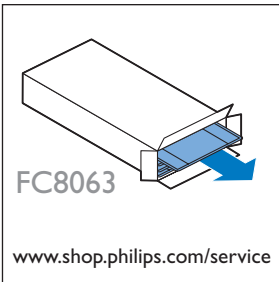
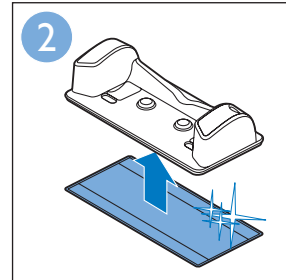
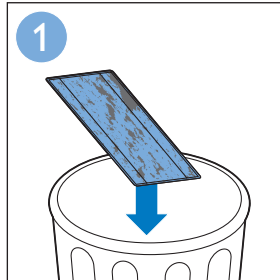
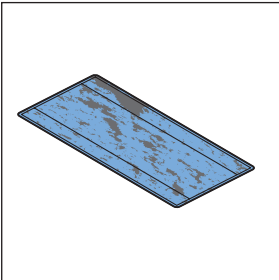
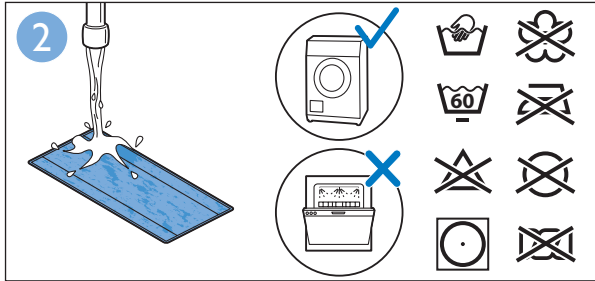
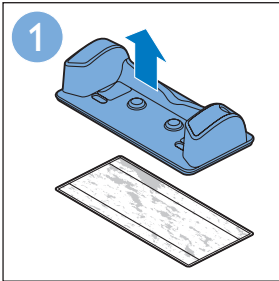

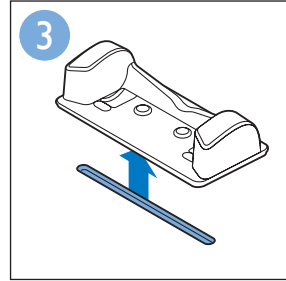
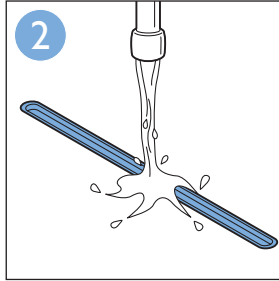
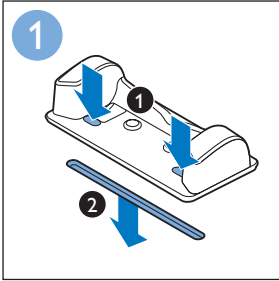
A diagram showing a white plastic blade holder with a blue blade inserted. A blue arrow points to the blade.

CP0178/01

A blue icon of a person reading a book.A black warning triangle icon with an exclamation mark inside, positioned above a document icon.

PHILIPS

www.philips.com/support



