

FILTRA PRO INOX & DESIGN

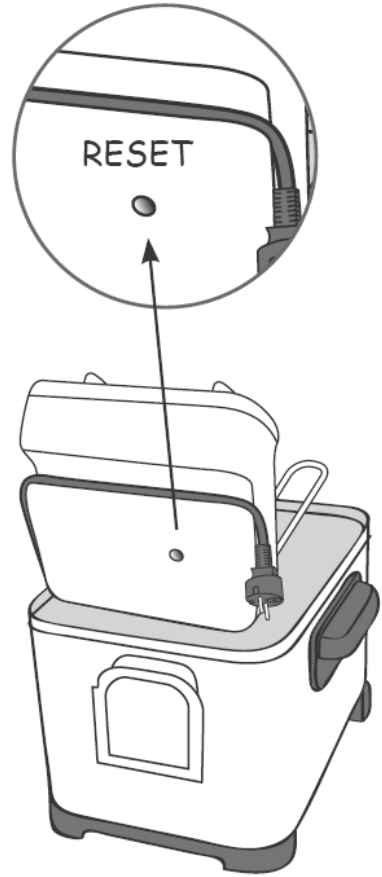

www.groupeseb.com

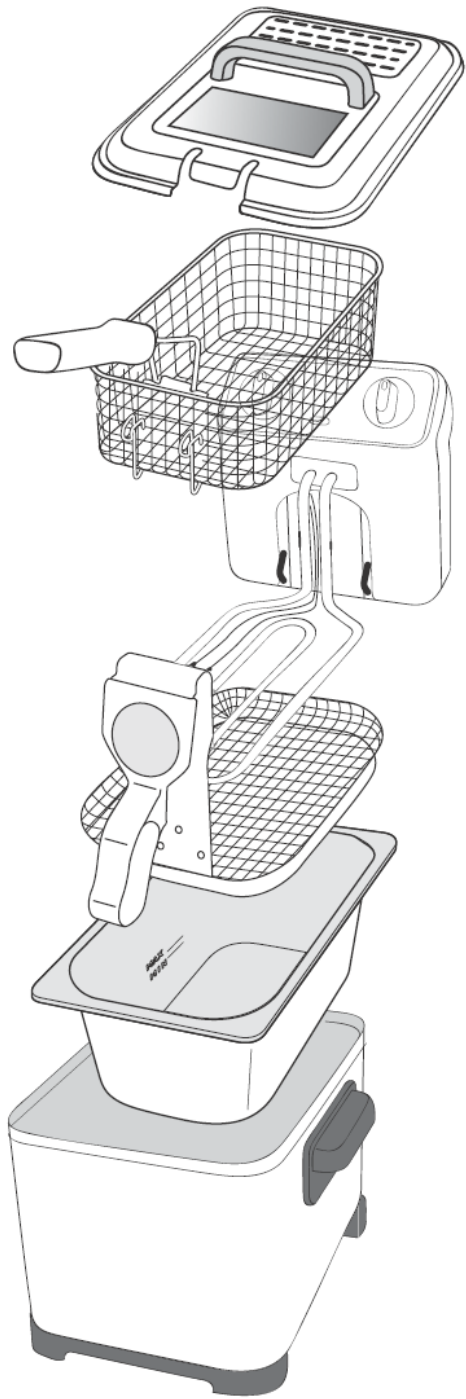



1

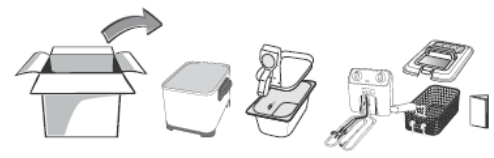

2

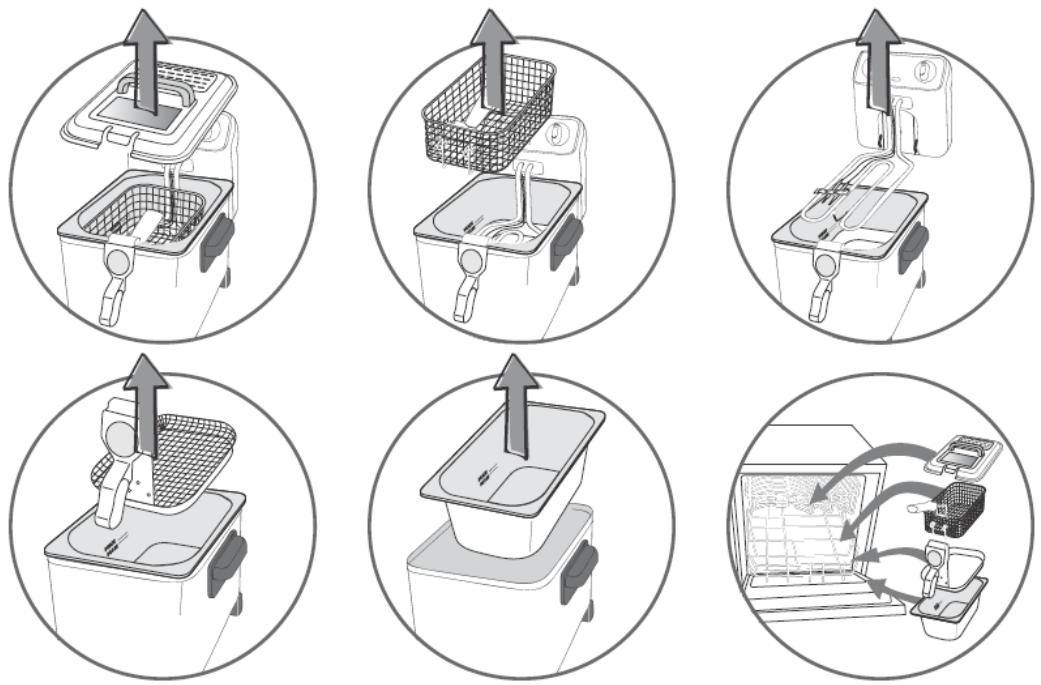

3

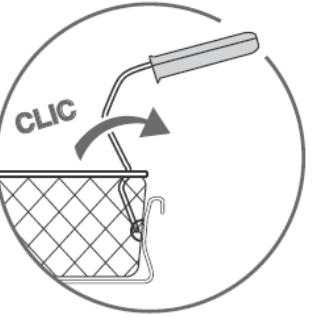
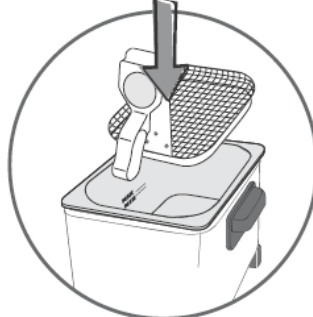
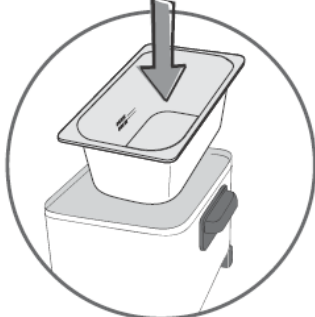
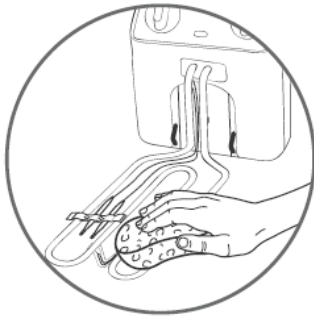



Model	3L	4L
Min.	2,2L	3,3L
Max.	3L	4L



Model	3L	4L
Min.	1925g	2890g
Max.	2625g	3500g



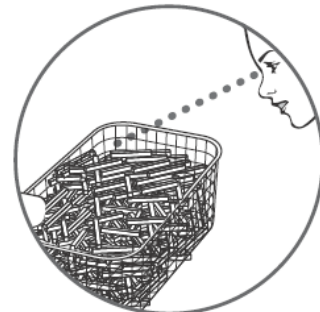
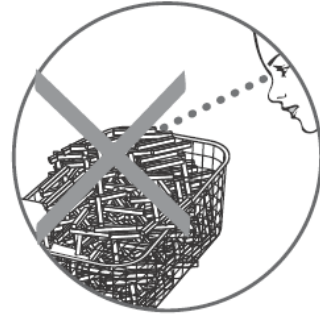
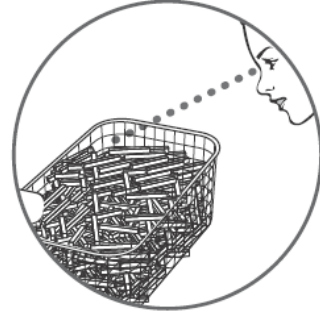

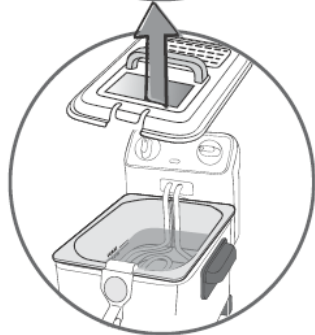
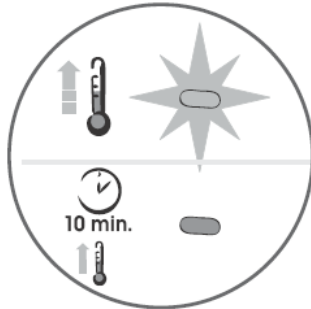
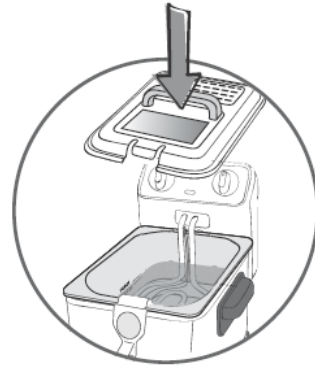
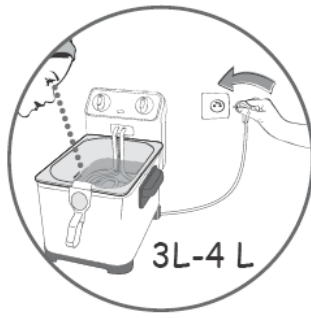

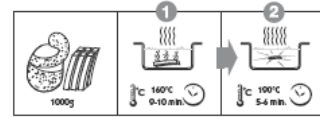

	Nb		°C	
		1000g	① 160°C	7-8 min.
			② 190°C	5-6 min.
		600g	170°C	9-10 min.
		800g	180°C	9-10 min.
		800g	① 160°C	6-7 min.
			② 190°C	3-4 min.
		400g	170°C	8-9 min.
		700g	180°C	9-10 min.
		400g	160°C	6-8 min.
	8-9		170°C	5-6 min.
* * *			°C	
		450g	170°C	7-8 min.
		900g	190°C	8-9 min.
		300g	170°C	6-7 min.
		600g	190°C	7-8 min.
	12		190°C	6-7 min.
		1300g	190°C	7-8 min.
		1200g	190°C	7-8 min.
	10-12		190°C	6-8 min.



7

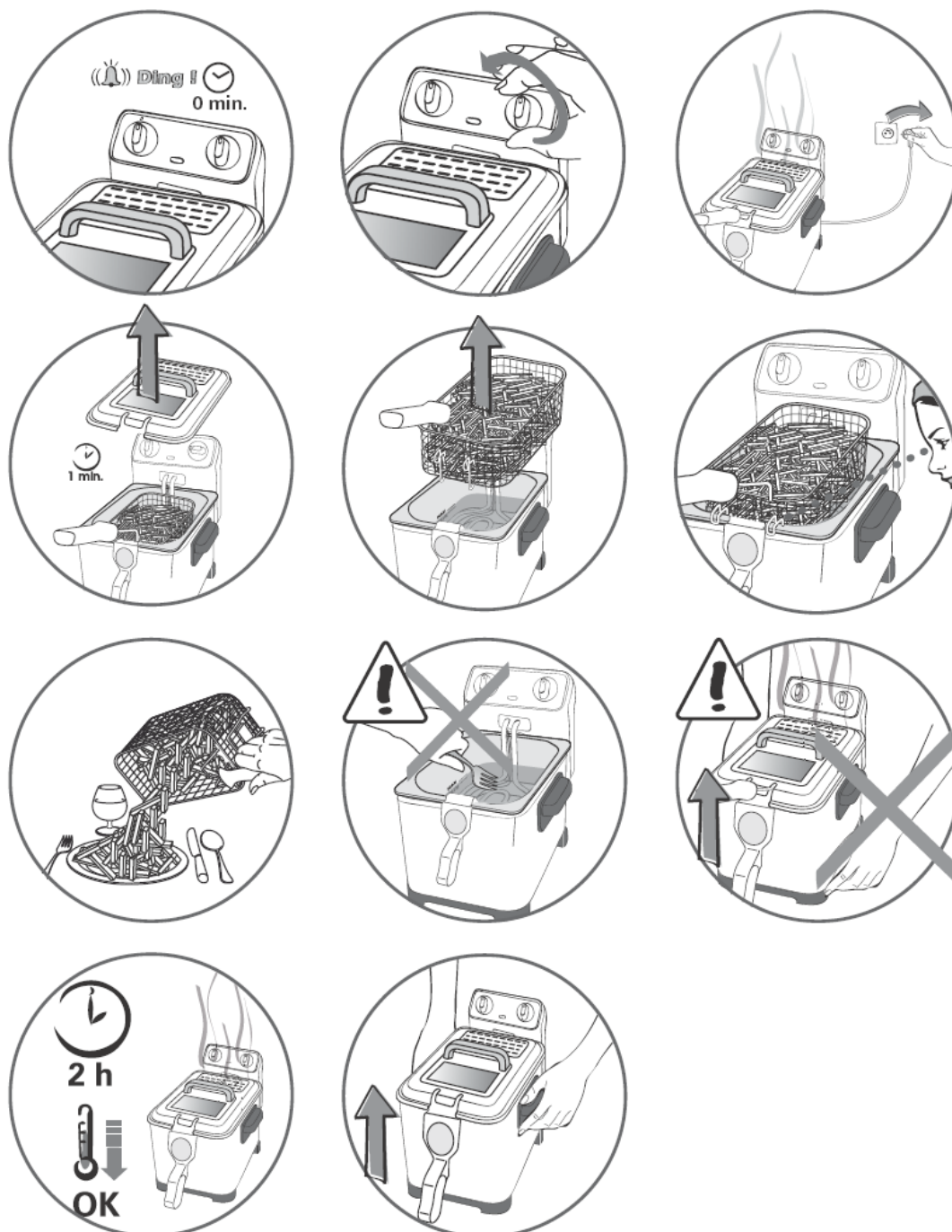

9

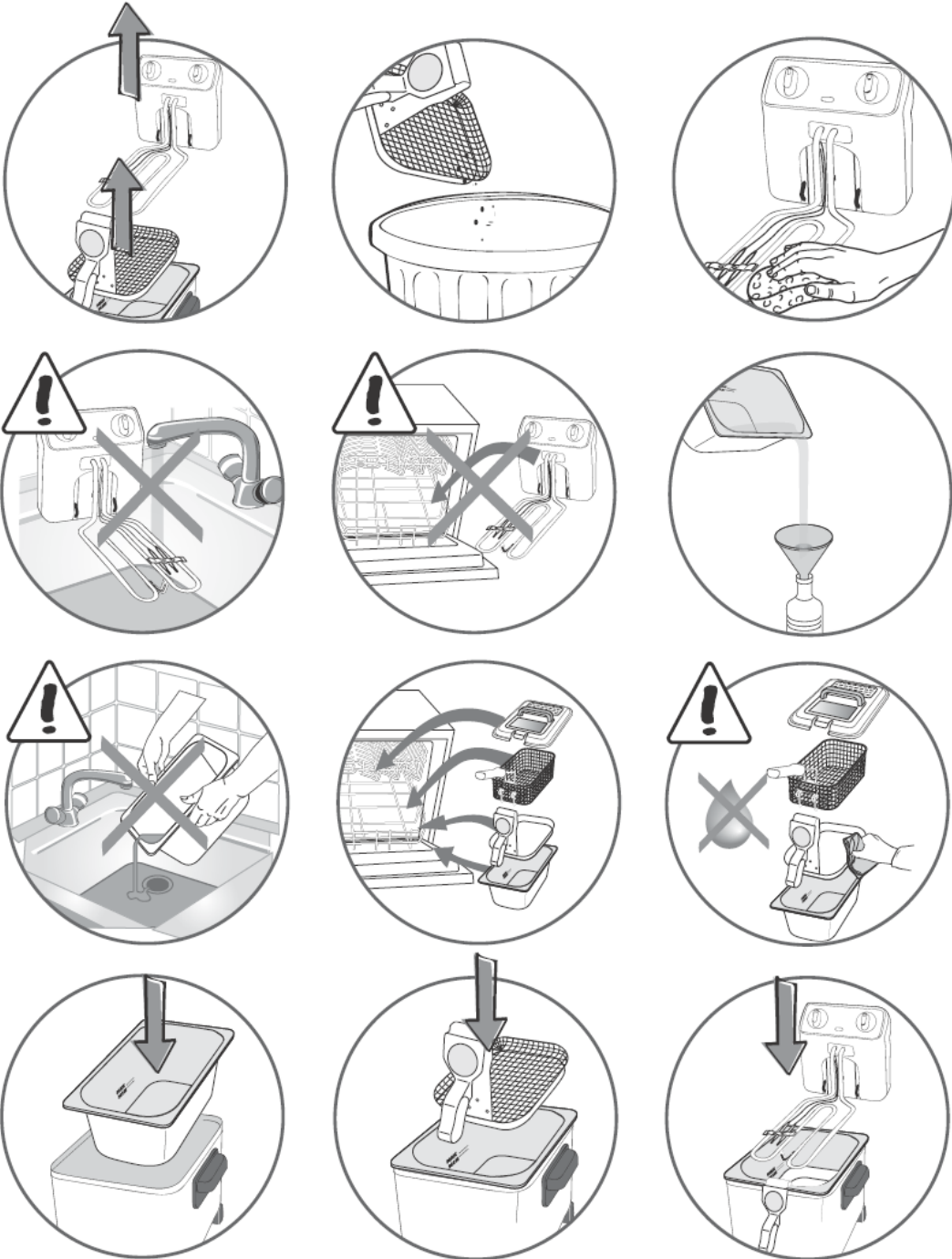
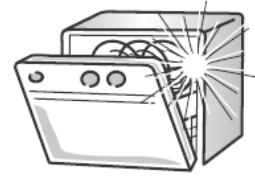

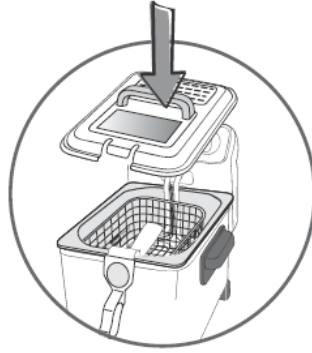
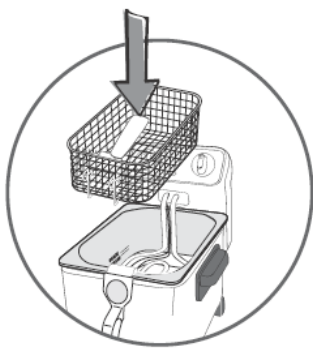

9

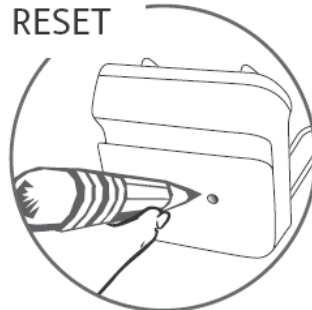



10

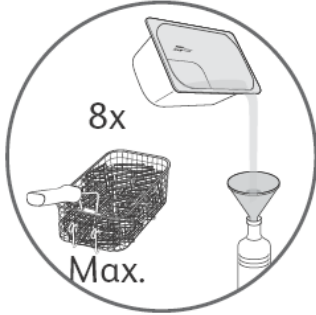

11

