

---

**ZEROWATT**

---

LAVASTOVIGLIE  
LAVE-VAISSELLE  
GESCHIRRSPÜLER  
LAVAVAJILLAS  
DISHWASHER  
MÁQUINA DE LAVAR LOIÇA

---

**ZL 831/1**

**ECO**

## Descrizione dei comandi

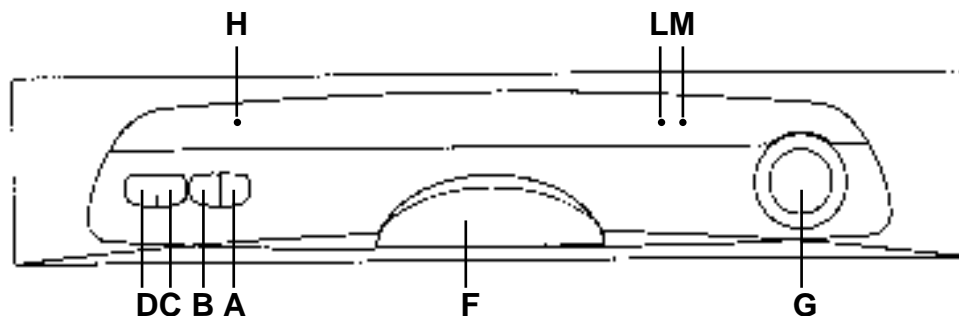

- A** Tasto di avvio e arresto
- B** Tasto lavaggio mezzo carico
- C** Tasto Economia
- D** Tasto bicchieri
- F** Maniglia di apertura sportello
- G** Manopola di selezione programmi
- H** Spia luminosa di funzionamento
- L** Spia luminosa esaurimento sale
- M** Spia luminosa Stand-By per ciclo R

## Dimensioni:

		con piano lavoro	senza piano lavoro
Altezza	cm	85	82
Profondità	cm	60	56
Larghezza	cm	60	59,7
Ingombro con porta aperta	cm	120	117

## Dati Tecnici

Coperti I.E.C.	12
Capacità con pentole e piatti	8 persone
Pressione ammessa nell'impianto idraulico:	Min. 0,08 - Max 0,8 MPa
Ampere fusibile	(vedere targhetta dati)
Potenza max assorbita	(vedere targhetta dati)
Tensione d'alimentazione	(vedere targhetta dati)



### Attenzione

Questa lavastoviglie è dotata di un dispositivo di sicurezza anti allagamento, funzionante anche in assenza di energia elettrica, che blocca automaticamente l'afflusso dell'acqua nel caso che questa superi il normale livello a causa di un eventuale malfunzionamento.

### Importante

Per evitare l'intervento intempestivo del dispositivo di sicurezza antiribocco, si raccomanda di non muovere o inclinare la lavastoviglie durante il funzionamento.

Nel caso sia necessario muovere o inclinare la lavastoviglie, assicurarsi prima che abbia completato il ciclo di lavaggio e che non ci sia acqua nella vasca.

## Scelta del programma e funzioni particolari

Per impostare il programma, ruotare la manopola in senso orario fino a far coincidere l'indice (▼) con il simbolo del programma scelto, quindi premere il tasto (Avvio/Arresto). Accertarsi che il rubinetto dell'acqua sia aperto, che la porta sia ben chiusa.



### Tasto lavaggio mezzo carico

Premendo questo tasto si può scegliere di lavare una quantità ridotta di stoviglie concentrando tutto il carico sul cesto superiore ad esclusione delle posate che dovranno essere posizionate nell'apposito cestello posto nel cesto inferiore.

La scelta di questa funzione permette di ridurre i consumi di acqua e di energia.

Per il lavaggio dosare il detersivo in quantità ridotta a quella consigliata per il lavaggio normale.



### Tasto Economia

Il tasto «E» riduce il riscaldamento finale dell'acqua durante l'ultimo risciacquo. Si attiva così una asciugatura naturale come nei normali scolapiatti, semplicemente socchiudendo la porta a fine ciclo per favorire la circolazione naturale dell'aria.



Il tasto E consente un risparmio di energia di oltre il 20% e abbrevia il ciclo. Consigliato per il lavaggio serale, quando non si desidera riavere subito, perfettamente asciutte, le stoviglie appena lavate.





# ELENCO DEI PROGRAMMI

Programma	Simbolo	Descrizione
-----------	---------	-------------

## programmi energici e delicati

<b>1</b>		<b>Intensivo</b> Adatto al lavaggio di pentole e di tutte le altre stoviglie di uso quotidiano particolarmente sporche.
<b>2</b>		<b>Universale</b> Adatto al lavaggio di stoviglie e pentole di uso quotidiano normalmente sporche. Programma normalizzato I.E.C. 436.
<b>3</b>	<b>ECO</b>	<b>Eco 55°C</b> Adatto al lavaggio di stoviglie e pentole di uso quotidiano normalmente sporche utilizzando detersivi contenenti enzimi. Programma normalizzato EN 50242.
<b>4</b>		<b>Delicato</b> Adatto al lavaggio di stoviglie delicate e con decorazioni e cristalleria. Indicato anche per il lavaggio di stoviglie d'uso quotidiano poco sporche, ad esclusione delle pentole.
<b>5</b>		<b>Risciacquo caldo e scaldapiatti</b> Adatto al risciacquo di stoviglie non usate da un certo periodo e per riscaldare stoviglie da usare per servire a tavola determinate portate.

## programmi rapidi

<b>-</b>		<b>Preriscaldamento</b> Fase di riscaldamento dell'acqua da eseguire prima di introdurre le stoviglie.
<b>6</b>	<b>R</b>	<b>Rapido 18 minuti</b> Ciclo superveloce da eseguire a fine pasto dopo il preriscaldamento dell'acqua indicato per un lavaggio di stoviglie fino a 4/6 persone.
<b>7</b>		<b>Prelavaggio freddo</b> Breve prelavaggio per le stoviglie usate al mattino o mezzogiorno, <u>quando si vuole rimandare il lavaggio del carico</u> completo dopo la cena.

	Operazioni da compiere					Svolgimento del Programma					Durata media in minuti	Funzioni facoltative		
	Detersivo Prelavaggio	Detersivo lavaggio	Pulizia filtro e piastra	Controllo scorta brillante	Controllo scorta sale	Prelavaggio caldo	Prelavaggio freddo	Lavaggio	Risciacquo intermedio	Risciacquo caldo con brillante		Con acqua fredda (15°C)	Tasto Economia	Tasto Bicchieri

	●	●	●	●	●	○		65°C	○	○	105	SI		SI
	●	●	●	●	●		○	65°C	○	○	100	SI		SI
		●	●	●	●			55°C	○	○	80	SI		SI
		●	●	●	●			55°C	○	○	70	SI	SI	SI
			●	●				68°C	○	○	55			SI

											15			SI
		●	●					60°C	○		18			SI
			●				○				5			SI

## Description de la machine

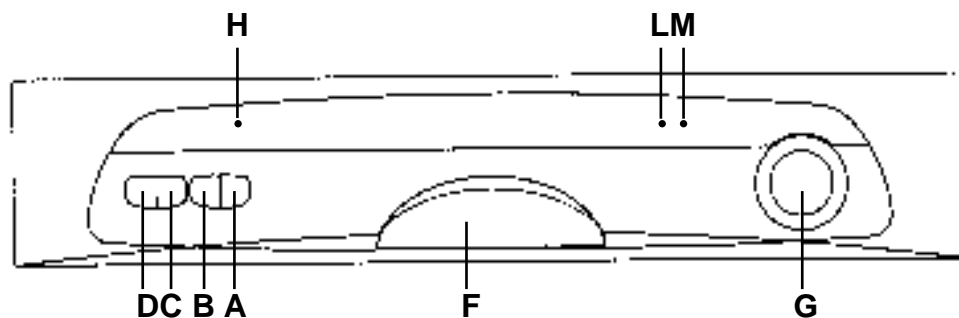

- |  |  |
|--|--|
| <b>A</b> Touche Marche/Arrêt                   | <b>G</b> Manette de sélection des programmes           |
| <b>B</b> Touche 1/2 charge                     | <b>H</b> Témoin lumineux de fonctionnement             |
| <b>C</b> Touche Economie                       | <b>L</b> Témoin lumineux de recharge nécessaire du sel |
| <b>D</b> Touche Verres                         | <b>M</b> Témoin lumineux Stand-By pour cycle Rapide    |
| <b>F</b> Poignée d'ouverture du lave-vaisselle |  |

## Dimensions:

		avec plan de travail	sans plan de travail
Hauteur	cm	85	82
Profondeur	cm	60	56
Largeur	cm	60	59,7
Encombrement porte ouverte	cm	120	117

## Données techniques:

Couvert I.E.C.	12
Capacité avec casseroles et assiettes	8 personnes
Pression admise pour l'installation hydraulique	Min. 0,08 - Max 0,8 MPa (voir plaque signalétique)
Fusible	(voir plaque signalétique)
Puissance maximum absorbée	(voir plaque signalétique)
Tension	(voir plaque signalétique)



### Attention

Ce lave-vaisselle est équipé d'un dispositif de sécurité anti-débordement, fonctionnant même en l'absence de courant électrique, qui bloque automatiquement l'écoulement de l'eau au cas où celle-ci dépasserait le niveau normal à cause d'une panne éventuelle.

### Important

Pour éviter le déclenchement intempestif du dispositif de sécurité anti-débordement, il est recommandé de ne pas remuer ou incliner le lave-vaisselle pendant son fonctionnement.

Au cas où il serait nécessaire de remuer ou d'incliner le lave-vaisselle, s'assurer d'abord que le cycle de lavage est terminé et qu'il n'y a plus d'eau dans la cuve.

## Sélection du programme et fonctions particulières

Pour choisir le programme, tourner la manette dans le sens des aiguilles d'une montre jusqu'à faire coïncider l'indice (▼) avec le symbole du programme choisi, appuyer sur la touche  (Marche/Arrêt). S'assurer que le robinet d'eau est ouvert, et que la porte soit bien fermée.



### Touche 1/2 charge

En enclenchant cette touche, il est possible de limiter le lavage de la vaisselle contenue dans le panier supérieur, à l'exclusion des couverts qui seront placés dans le panier inférieur.

Le choix de cette fonction permet de réduire les consommations d'eau et d'énergie.



### Touche Economique

La touche "E" réduit le chauffage de l'eau au cours du dernier rinçage.

Un séchage naturel est ainsi déclenché en ouvrant légèrement la porte, à la fin du cycle, pour permettre la circulation de l'air. La touche "E" permet d'économiser 20% d'énergie et de raccourcir le temps du cycle.

Recommandée pour les lavages du soir lorsque la vaisselle n'a pas besoin d'être parfaitement sèche dès la fin du lavage.







# LISTE DES PROGRAMMES

Programme	Symbole	Description
-----------	---------	-------------

	Opérations à accomplir					Déroulement du programme					Durée moyenne en minutes	Fonctions facultatives		
	Lessive pré-lavage	Lessive lavage	Nettoyage plaque, filtre	Contrôle provision du produit de rinçage	Contrôle provision Sel	Pré-lavage chaud	Pré-lavage froid	Lavage	Rinçage intermédiaire	Rinçage chaud avec produit de rinçage		Avec eau froide (15°C)	Touche Economie	Touche 1/2 charge

## programmes énergiques et délicats

<b>1</b>		<b>Intensif</b> Conçu pour le lavage des casseroles et de toute autre vaisselle d'un usage quotidien particulièrement sale.
<b>2</b>		<b>Universel</b> Destiné au lavage de la vaisselle et casseroles d'un usage quotidien normalement sale. Programme selon la norme I.E.C. 436.
<b>3</b>	<b>ECO</b>	<b>Eco 55°C</b> Adapté au lavage de vaisselle et casseroles d'usage quotidien, normalement sales, avec utilisation de lessive à base d'enzyme. Programme normalisé EN 50242.
<b>4</b>		<b>Délicat</b> Adapté au lavage de la vaisselle délicate décorée et en cristal. Indiqué pour le lavage de la vaisselle d'usage quotidien peu sale, à l'exclusion des casseroles.
<b>5</b>		<b>Chauffe assiettes</b> Adapté au rinçage de la vaisselle non utilisée depuis un certain temps, et pour servir à table des assiettes chaudes pour certains mets.

	<input checked="" type="checkbox"/>	<input checked="" type="checkbox"/>	<input checked="" type="checkbox"/>	<input checked="" type="checkbox"/>	<input checked="" type="checkbox"/>	<input type="checkbox"/>		65°C	<input type="checkbox"/>	<input type="checkbox"/>	105	OUI	OUI	
	<input checked="" type="checkbox"/>	<input checked="" type="checkbox"/>	<input checked="" type="checkbox"/>	<input checked="" type="checkbox"/>	<input checked="" type="checkbox"/>	<input type="checkbox"/>		65°C	<input type="checkbox"/>	<input type="checkbox"/>	100	OUI	OUI	
		<input checked="" type="checkbox"/>	<input checked="" type="checkbox"/>	<input checked="" type="checkbox"/>	<input checked="" type="checkbox"/>			55°C	<input type="checkbox"/>	<input type="checkbox"/>	80	OUI	OUI	
		<input checked="" type="checkbox"/>	<input checked="" type="checkbox"/>	<input checked="" type="checkbox"/>	<input checked="" type="checkbox"/>			55°C	<input type="checkbox"/>	<input type="checkbox"/>	70	OUI	OUI	OUI
			<input checked="" type="checkbox"/>	<input checked="" type="checkbox"/>				68°C	<input type="checkbox"/>	<input type="checkbox"/>	55		OUI	

## programmes rapides

<b>-</b>		<b>Préchauffage</b> Phase de chauffage de l'eau à effectuer avant d'introduire la vaisselle.
<b>6</b>	<b>R</b>	<b>Rapide 18'</b> Cycle très rapide à effectuer à la fin du repas, après le préchauffage de l'eau. Recommandé pour un lavage de vaisselle jusqu'à 4/6 personnes.

											15		OUI
		<input checked="" type="checkbox"/>	<input checked="" type="checkbox"/>					60°C	<input type="checkbox"/>		18		OUI

<b>7</b>		<b>Trempage</b> Pour la vaisselle utilisée le matin ou à midi quand on souhaite effectuer le lavage de la charge après le dîner.
----------	---	---

		<input checked="" type="checkbox"/>					<input type="checkbox"/>				5		OUI
--	--	-------------------------------------	--	--	--	--	--------------------------	--	--	--	---	--	-----

## Beschreibung der Bedienelemente

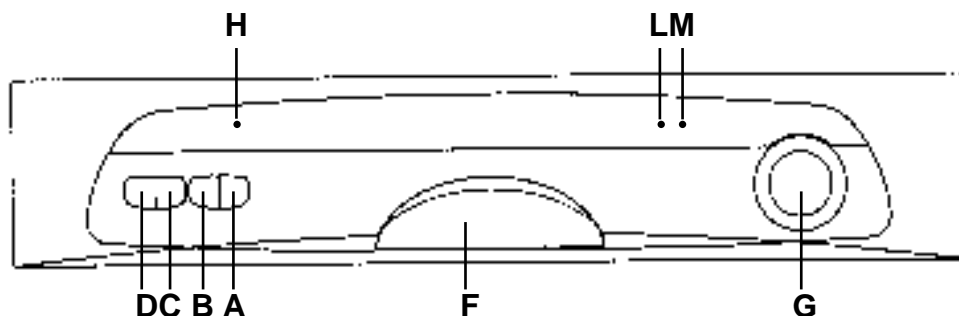

- |  |   |
|--|---|
| <b>A</b> Start/Stop Taste              | <b>G</b> Programmwahlschalter                       |
| <b>B</b> Taste Sparspülprogramm 1/2    | <b>H</b> Funktionslampe                             |
| <b>C</b> Spartaste "E"                 | <b>L</b> Salz Kontrollanzeige                       |
| <b>D</b> Schon-Taste                   | <b>M</b> Anzeige Warteposition für Spülzyklus Rapid |
| <b>F</b> Griffmulde zum Öffnen der Tür |   |

## Maße:

		mit Arbeitsplatte	ohne Arbeitsplatte
Höhe	cm	85	82
Breite	cm	60	59,7
Tiefe	cm	60	56
Tiefe bei geöffneter Tür	cm	120	117

## Technische Daten:

Fassungsvermögen	12 Maßgedecke
Ventildruck der Hydraulikanlage	Min. 0,08 - Max 0,8 MPa
Absicherung	(s. Matrikelschild)
Gesamtanschlußwert	(s. Matrikelschild)
Spannung	(s. Matrikelschild)



### Achtung!

Dieser Geschirrspüler ist mit einem Waterblock-Sicherheitssystem versehen, das unabhängig von der Stromversorgung funktioniert. Am Einlaßventil wird im Falle einer störungsbedingten Erhöhung der Wasserzufuhr diese automatisch blockiert.

### Wichtig!

Um ein ungewolltes Auslösen dieses Sicherheitsventils zu verhindern, sollte der Geschirrspüler während seines Betriebs nicht bewegt oder gereinigt werden.

Falls Sie einmal das Gerät verrücken müssen, achten Sie darauf, daß es außer Betrieb ist und in der Bodenwanne kein Wasser steht.

## Wahl der Programme und einzelnen Funktionen

Drehen Sie den Programmschalter im Uhrzeigersinn so, daß das von Ihnen gewünschte Programm und die Anzeige (▼) zusammentreffen. Dann drücken Sie die START/STOP-Taste. Überprüfen Sie zuvor, daß die Tür gut geschlossen und der Absperrhahn aufgedreht ist.



### Taste Sparspülprogramm 1/2

Wenn wenig Geschirr gespült werden soll, können Sie durch Drücken dieser Taste die Funktion nur Oberkorbspülen wählen. Das Geschirr wird hierzu nur in den Oberkorb geladen, während das Besteck wie üblich im Besteckkorb im unteren Korb eingeordnet wird.

Das Sparprogramm 1/2 ermöglicht eine Reduzierung der Wasser- und Stromverbrauchswerte.

Setzen Sie entsprechend weniger Spülmittel ein.



### Spartaste Eco

Durch die Taste "E" wird die Heizphase beim letzten Nachspülen reduziert. So kann das Geschirr auf natürlicher Weise trocknen, ähnlich wie beim herkömmlichen Abwasch per Hand. Öffnen Sie nach dem Ende des Programmes die Tür und lehnen Sie diese nach Möglichkeit leicht an, damit eine bessere Luftzirkulation möglich ist. Die Taste "E" ermöglicht eine Energieersparnis von über 20% und verkürzt außerdem die Programmdauer.

Diese Option empfiehlt sich besonders am Abend und zu anderen Gelegenheiten, zu denen man das Geschirr nicht sofort ausräumen will oder kann.





### Schon-Taste



Im Spülprogramm aktiviert die Schon-Taste einen besonders schonenden Spülgang bei 45°C, geeignet zum Reinigen empfindlicher Gläser.



### Vorwärmung des Wassers für Schnellspülgang

Um den Schnellspülgang zu aktivieren, muß das Wasser vorgewärmt sein.

Stellen Sie den Programmwahlschalter auf  und drücken Sie die START/STOP Taste. Sie können dies einfach eine Viertelstunde vor dem Ende der Mahlzeit tun. Während dieser Zeit wird das Wasser in ihrem Geschirrspüler erwärmt. Steht der Programmwahlschalter auf Stop, leuchtet automatisch die Signallampe für die Warteposition «R» auf. Das Gerät kann dann beladen werden. Dazu wird durch Betätigen der START/STOP Taste die Tür entriegelt. Öffnen Sie die Tür, füllen Sie Geschirrspülmittel in die Einfüllkammer der Maschine und verteilen Sie das Geschirr auf die beiden Geschirrkörbe.



### Schnelldurchlauf 18 Minuten

Programmwahlschalter auf dieses Symbol stellen und START/STOP Taste betätigen. Nach ca. 18 Minuten ist dieser Spülvorgang beendet. Schalten Sie über die Tür an, um die natürliche Trocknung des Geschirrs zu unterstützen.

### Ende des Spülprogrammes

Wenn der Programmknopf auf dem Symbol (  ) stehen bleibt, ist das Spülprogramm beendet.





Drücken Sie die Taste  , um den Geschirrspüler auszuschalten, und öffnen Sie erst dann die Tür.

Lined writing area for user notes

# LISTE DER PROGRAMME

Programm	Symbol	Beschreibung
----------	--------	--------------

## Standard-Programme

<b>1</b>		<b>Intensiv-Programm</b> Für alle Töpfe und stark verschmutztes Geschirr.
<b>2</b>		<b>Normal-Programm</b> Für normal verschmutzte Töpfe und Geschirr. Das Programm entspricht dem Normprogramm I.E.C. 436.
<b>3</b>	<b>ECO</b>	<b>Eco 55°C</b> Für normal verschmutzte Töpfe und Geschirr bei Verwendung von Spülmitteln mit Enzymen. Das Programm entspricht der Normen EN 50242.
<b>4</b>		<b>Schonspülen</b> Für den Abwasch von empfindlichem Geschirr, Geschirr mit Dekoren, sowie Gläsern und Kristallgefäßen. Auch zu empfehlen für nur leicht verschmutztes Geschirr des täglichen Gebrauchs. Für Töpfe nicht geeignet.
<b>5</b>		<b>Nachspül- und Trocken-Programm</b> <b>Teller- Wärmen</b> Zur Entstaubung des Geschirrs, das lange ungebraucht blieb. Dieses Programm kann auch als "Tellervorwärmer" bei besonders heiß zu servierenden Gerichten Verwendung finden.

## Schnell-Programme

<b>-</b>		<b>Vorerwärmung des Wassers</b> Vorwärmphase vor der Eingabe des Geschirrs.
<b>6</b>	<b>R</b>	<b>Schnellgang 18 Minuten</b> Schnellprogramm mit Vorwärmphase. Das Aufheizen des Wassers kann bereits während der Mahlzeit erfolgen.

<b>7</b>		<b>Vorspülen kalt</b> Kurzer Vorspülgang, für Gedecke, die nach dem Frühstück oder Mittagessen in der Maschine bleiben, und erst am Abend gespült werden sollen.
----------	---	---

	Arbeitsgänge					Programmabläufe					Durchschnittliche Programmdauer in Minuten	Zusatzfunktionen		
	Reinigungsmittel für Vorspülprogramm	Spülmittel	Filter-und Arbeitsplattenreinigung	Kontrolle des Klaspülvorrats	Kontrolle des Salzvorrats	Vorspülen (warm)	Vorspülen (kalt)	Hauptspülgang	Zwischenspülgang	Nachspülen (warm) mit Klarspüler		Kaltwasseranschluss 15 Grad C.	Spartaste "E"	Sparspülprogramm 1/2

	●	●	●	●	●	○		65°C	○	○	105	JA	JA	
	●	●	●	●	●		○	65°C	○	○	100	JA	JA	
		●	●	●	●			55°C	○	○	80	JA	JA	
		●	●	●	●			55°C	○	○	70	JA	JA	JA
			●	●				68°C	○	○	55		JA	

											15		JA	
		●	●					60°C	○		18		JA	

			●								5		JA	
--	--	--	---	--	--	--	--	--	--	--	---	--	----	--

## Descripción de los mandos

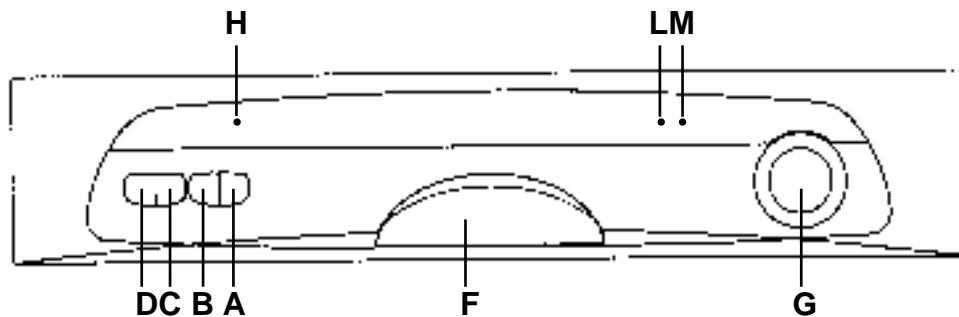

- |   |   |
|---|---|
| <b>A</b> Tecla de paro/marcha             | <b>G</b> Mando de selección de programas            |
| <b>B</b> Tecla media carga                | <b>H</b> Piloto luminoso de funcionamiento          |
| <b>C</b> Tecla de ahorro E                | <b>L</b> Piloto luminoso indicador falta de sal     |
| <b>D</b> Tecla programa delicado          | <b>M</b> Piloto luminoso "Stand-By" para el ciclo R |
| <b>F</b> Manilla de apertura de la puerta |   |

## Dimensiones:

		con plano de trabajo	sin plano de trabajo
Altura	cm	85	82
Profundidad	cm	60	56
Anchura	cm	60	59,7
Ocupación con puerta abierta	cm	120	117

## Datos Técnicos:

Cubiertos I.E.C.	12
Capacidad con cacerolas y platos	8 personas
Presión admitida en la instalación eléctrica	Min. 0,08 - Max 0,8 MPa
Amperios fusibles	(véase placa de características)
Potencia máxima absorbida	(véase placa de características)
Tension	(véase placa de características)



### Atencion

Este lavavajillas está dotado de un dispositivo de seguridad antidesbordamiento, que también funciona sin energía eléctrica, bloquea automáticamente el flujo del agua, en el caso que ésta supere el nivel normal a causa de un mal funcionamiento.

### Importante

Para evitar que se dispare el dispositivo de seguridad anti-desbordamiento, se recomienda no mover o inclinar el lavavajillas durante el funcionamiento.

En el caso que sea necesario mover o inclinar el lavavajillas, asegurarse primero que haya completado el ciclo de lavado y que no quede agua en la cuba.

## Selección de los programas y funciones especiales

Para seleccionar el programa, girar el mando en sentido horario hasta hacer coincidir el índice (▼) con el símbolo del programa seleccionado, y presionar entonces el mando (paro/marcha). Asegurarse de que el grifo del agua está abierto, y la puerta bien cerrada.



### Tecla media carga

Pulsando esta tecla se puede elegir lavar una cantidad reducida de vajillas concentrando toda la carga sobre el cesto superior excluidos los cubiertos que deberán ser colocados en la cesta específica en el cesto inferior.

La elección de esta función permite reducir los consumos de agua y energía.

Para el lavado dosificar el detergente en cantidad menor a la aconsejada para el lavado normal.



### Tecla de Economía

La tecla "E" reduce el calentamiento final del agua en el último aclarado. Se activa de esta forma un secado natural como en los tradicionales "escurre platos" simplemente entreabriendo la puerta al final del ciclo para favorecer la circulación de aire.

La tecla "E" permite un ahorro de energía de más del 20% y reduce la duración del ciclo.



Aconsejado para un lavado en horas nocturnas, cuando no se necesita de manera rápida, perfectamente seca, la vajilla y resto de utensilios.





# RELACION DE LOS PROGRAMAS

Programas	Símbolo	Descripción
-----------	---------	-------------

## programas enérgicos y delicados

1		<b>Intensivo</b> Apto para lavar cacerolas y toda la vajilla de uso diario especialmente sucia.
2		<b>Universal</b> Apto para lavar la vajilla y cacerolas de uso diario con suciedad normal. Programa normalizado IEC 436.
3	<b>ECO</b>	<b>Eco 55°C</b> Indicado para el lavado de vajillas y ollas de uso cotidiano con suciedad normal utilizando detergentes con enzimas. Programa normalizado EN 50242.
4		<b>Delicado</b> Apto para lavar la vajilla delicada y con decoración, así como la cristalería. Indicado también para lavar la vajilla delicada de uso diario poco sucia, a excepción de las sartenes.
5		<b>Aclarado caliente y calentaplatos</b> Adecuado para el aclarado de vajillas no utilizadas en un cierto tiempo y para calentar vajillas para servir determinados platos.

## programas rápidos

-		<b>Pre calentamiento</b> Fase de calentamiento del agua que se efectúa antes de introducir la vajilla.
6	<b>R</b>	<b>Rápido 18 minutos</b> Ciclo superrápido que se efectúa al final de la comida después del pre calentamiento del agua, indicado para un lavado de vajilla hasta de 4/6 personas.
7		<b>Prelavado frío</b> Breve prelavado para la vajilla usada en la mañana o al mediodía, cuando se quiere realizar un sólo lavado completo después de la cena.

	Operaciones a realizar					Desarrollo del programa					Duración media en minutos:	Funciones facultativas		
	Detergente prelavado	Detergente lavado	Limpieza filtro y placa	Control nivel del abrillantador	Control nivel de la sal	Prelavado caliente	Prelavado frío	Lavado	Aclarado intermedio	Aclarado caliente con abrillantador		Con agua fría (15°C)	Tecla media carga	Tecla programa delicado

	●	●	●	●	●	○		65°C	○	○	105	SI		SI
	●	●	●	●	●		○	65°C	○	○	100	SI		SI
		●	●	●	●			55°C	○	○	80	SI		SI
		●	●	●	●			55°C	○	○	70	SI	SI	SI
			●	●				68°C	○	○	55	SI		

											15	SI		
		●	●					60°C	○		18	SI		
			●				○				5	SI		

## Description of the controls

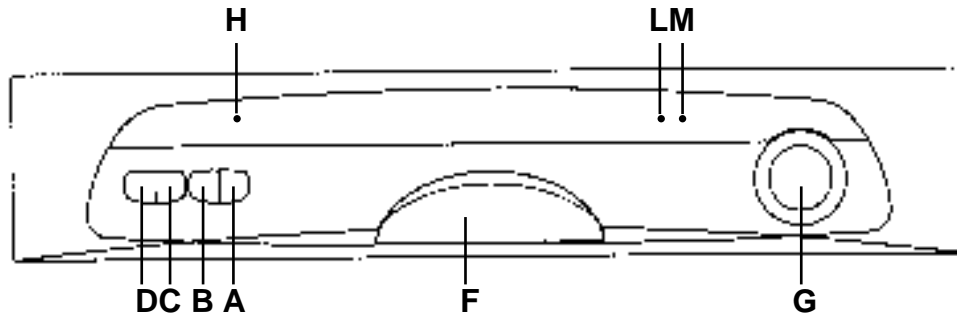

- |                           |   |
|---------------------------|---|
| <b>A</b> On/off button    | <b>G</b> Programme selector                       |
| <b>B</b> Half load button | <b>H</b> Mains indicator light                    |
| <b>C</b> Economy button   | <b>L</b> Low level salt indicator light           |
| <b>D</b> Glass button     | <b>M</b> Stand-by pilot light for Rapid programme |
| <b>F</b> Door handle      |   |

## Dimensions:

		with working top	without working top
Height	cm	85	82
Depth	cm	60	56
Width	cm	60	59,7
Depth with door open	cm	120	117

## Technical Data

IEC place load	12
Capacity with pans and dishes	8 persons
Water supply pressure	Min. 0,08 - Max 0,8 MPa
Fuse	(see rating plate)
Power input	(see rating plate)
Supply voltage	(see rating plate)



### Attention

This dishwasher is equipped with an anti-overflow safety device which works even when power is switched off, and if the water level is too high, the supply will automatically be closed off.

### Important

To ensure the correct operation of the anti-overflow safety device, it is recommended not to move or to tilt the dishwasher during operation.

If it is necessary to move or to tilt the dishwasher, first make sure the washing cycle is finished and that no water is left in the tank.

## Selecting the programme and special functions

Use in conjunction with programme guide

To set the programme, turn the dial clockwise until the pointer (▼) indicates the symbol of the required programme. Then press the On/Off button . Ensure that the water supply is turned on and the door is closed properly.



### Half load button

By pressing this button it is possible to wash a small quantity of crockery using only the upper basket for dishes and cutlery in the bottom basket. This reduces water and energy consumption and requires a smaller quantity of detergent as well.



### Economy button

The "E" button reduces the temperature of the water during the last rinse. This activates a natural drying process, as with a normal draining board, simply by leaving the door ajar at the end of the cycle to enable the natural circulation of air. The "E" button provides an energy saving of more than 20% and shortens the cycle.

Recommended for evening washes when the dishes are not required perfectly dry, straight away.





### Glass button

By pressing this button in conjunction with the programme  your dishwasher will operate the wash at 45°C. Recommended for delicate glass.

### Pre-heating for rapid wash

For rapid wash, the water must be pre-heated.



Turn the knob to the symbol  and press the button . This should be done 15 minutes before you actually load the dishwasher. While you are finishing your meal, the dishwasher will automatically fill with water and then bring it to the correct temperature. So when the dial wash is on stop

position, the pilot light «R» comes on and the machine is ready to be loaded with dishes.

Switch it off by pressing the  button. Open the door, put the detergent in the dispenser and load the dishes carefully in the two baskets. One convenient way of doing this is to put the dishes in alternate grooves of the basket.





### 18' rapid wash

Turn the knob to the symbol and press the  button. After approximately 18' the wash will be completed. Switch off

by pressing the  button and open the door leaving it slightly ajar to aid the natural drying process.

### The cycle ends

When the program handle reaches the  symbol, the cycle ends. Push the On-Off  button to cut power to the dishwasher and then only open the door.

---

---

---

---

---

---

---

---

---

---

---

---

---

---

---

---

---

---

---

---

---

---

---

---

---

---

---

---

---

---

# PROGRAMMES SELECTION

Programme	Symbol	Description
-----------	--------	-------------

	Check list					Programme contents					Average duration in minutes	Special function buttons available		
	Detergent for soaking	Detergent for washing	Clean filter	Check rinse aid dispenser	Check salt container	Hot pre-wash	Cold pre-wash	Main wash	Intermediate rinse	Hot rinse with rinse aid		With cold water (15°C)	Economy button	Half load button

## Energetic and delicate programmes

<b>1</b>		<b>Intensive</b> Once a day - for heavily soiled pans and any other items that have been left all day for washing.
<b>2</b>		<b>Universal</b> Once a day - for normally soiled pans and any other items that have been left all day for washing. Programme standardised to IEC 436.
<b>3</b>	<b>ECO</b>	<b>Eco 55°C</b> Energy Saving Programme suitable for normal soiled items. Using detergents with enzyme. Programme standardised to EN 50242.
<b>4</b>		<b>Delicate</b> Suitable for delicate crockery and glassware. Also for less soiled items excluding pans.
<b>5</b>		<b>Hot rinsing cycle and warming cycle</b> Suitable for rinsing dishes which have not been used for some time and for warming dishes prior to serving.

	●	●	●	●	●	○		65°C	○	○	105	YES	YES	
	●	●	●	●	●		○	65°C	○	○	100	YES	YES	
		●	●	●	●			55°C	○	○	80	YES	YES	
		●	●	●	●			55°C	○	○	70	YES	YES	YES
			●	●				68°C	○	○	55		YES	

## Rapid programmes

<b>-</b>		<b>Pre-heating</b> Water is heated before the machine is loaded with dishes.
<b>6</b>	<b>R</b>	<b>18 minutes rapid</b> Quick wash for dishes which are to be washed immediately after the meal. Wash load of 4/6 persons.

											15		YES	
		●	●					60°C	○		18		YES	

<b>7</b>		<b>Cold pre-wash</b> Short cold pre-wash for items that are stored in the dishwasher until you are ready to wash a full load.
----------	--	--

		●					○				5		YES	
--	--	---	--	--	--	--	---	--	--	--	---	--	-----	--



## Descrição dos comandos

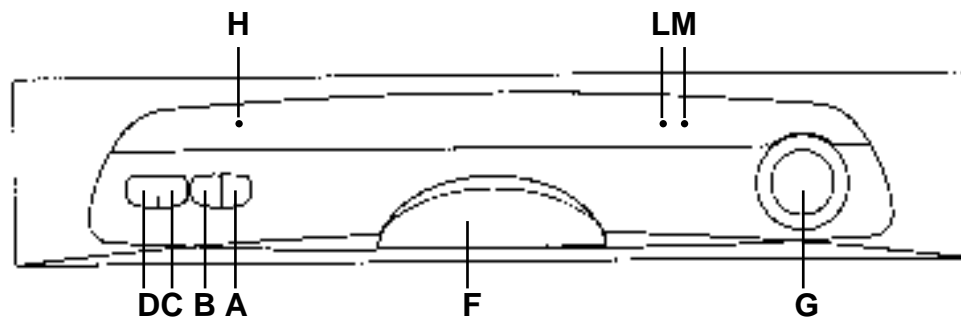

- A** Tecla de ligar/desligar
- B** Tecla de meia carga
- C** Tecla de economia E
- D** Tecla para cristais
- F** Dispositivo de abertura da porta
- G** Botão de selecção dos programas
- H** Indicador luminoso de funcionamento
- L** Indicador luminoso do nível de sal
- M** Indicador luminoso de Stand-By para o ciclo Rápido

## Dimensões

		com bancada	sem bancada
Altura	cm	85	82
Profundidade	cm	60	56
Largura	cm	60	59,7
Espaço ocupado c/ porta aberta	cm	120	117

## Dados Técnicos

Capacidade seg-norma I.E.C.	12 pessoas
Capacidade c/ tachos e pratos	8 pessoas
Pressão admitida na instalação hidráulica	Min. 0,08 - Max 0,8 MPa
Fusível	(ver placa de características)
Potência máxima absorvida	(ver placa de características)
Tensão	(ver placa de características)



### Atenção

Esta máquina está equipada com um dispositivo de segurança contra inundações que é activado mesmo que a máquina esteja desligada e que interrompe automaticamente o fluxo de água se, devido a uma possível avaria, a água ultrapassar o nível normal.

### Importante

A fim de evitar que o dispositivo de segurança contra inundações seja inoportunamente activado, recomenda-se que a máquina não seja deslocada ou inclinada enquanto estiver a funcionar.

Se for absolutamente necessário deslocar ou inclinar a máquina enquanto esta estiver a funcionar, assegure-se primeiro de que o ciclo de lavagem já terminou e que não há água na cuba da máquina.

## Seleção de programas e funções especiais

Para seleccionar os programas, deverá rodar o botão de selecção dos programas no sentido dos ponteiros do relógio até o respectivo símbolo coincidir com a marca (▼), e carregar então na tecla de ligar/desligar. Assegure-se de que a torneira da água esteja aberta e a porta bem fechada.



### Tecla de meia carga

Se se premir esta tecla, podese optar pela lavagem de uma quantidade reduzida de loiça, concentrando toda a loiça a lavar no tabuleiro superior, à excepção dos talheres, que deverão ser colocados no cesto existente para esse efeito, colocado no tabuleiro inferior da máquina.

A selecção desta função permite reduzir o consumo de água e de energia.

Colocar uma quantidade de detergente inferior à normalmente doseada para a lavagem normal.



### Tecla de economia "E"

A tecla de economia "E" reduz a fase de aquecimento final da água durante o último enxaguamento. É assim activado um processo de secagem natural da loiça, semelhante ao que tem lugar quando a loiça fica a secar nos escorredouros normais, para o que bastará abrir a porta no fim do ciclo de lavagem para favorecer a circulação natural do ar. Esta tecla de economia "E" permite poupar mais de 20% de energia e reduz a duração do ciclo de lavagem. Trata-se de uma função particularmente recomendada para a lavagem da loiça ao fim do dia, quando não se pretenda descarregar logo da máquina uma loiça perfeitamente seca.



### Tecla para cristais

Se, uma vez seleccionado o programa de lavagem (delicado), se premir esta tecla, a máquina lava a loiça a 45° C. Esta função é especialmente recomendada para a lavagem de cristais e de vidros delicados.



### Pré-aquecimento para ciclos rápidos

Para efectuar os ciclos rápidos é necessário programar o pré-aquecimento da água.

Rodar o botão até o símbolo e pressionar a tecla . Esta operação rápida e simples efectua-se um quarto de hora antes de carregar a máquina e de terminar a refeição. Enquanto acaba de comer, a sua máquina enche-se automaticamente de água e aquece-a. Quando o indicador de stop no botão de comando coincidir com a marca, o indicador luminoso «R» acende-se; a máquina está preparada para ser carregada com loiça.

Desligar a máquina de lavar loiça pressionando a tecla . Abrir a porta, introduzir o detergente no recipiente respectivo e colocar a loiça, distribuindo-a pelos dois cestos.

R

### Ciclo rápido 18'

Colocar o botão de selecção dos programas sobre o símbolo.

Pressionar a tecla , 18 minutos depois o ciclo termina. Entreabrir a porta para permitir a secagem natural da loiça.

### Fim de programa

O programa termina quando o botão de selecção de programas avança até ao símbolo

Pressione então a tecla para desligar a sua máquina da corrente e só depois abra a porta da máquina.

---

---

---

---

---

---

---

---

---

---

---

---

---

---

---

---

---

---

---

---

---

---

---

---

---

---

---

---





---

---



# TABELA DOS PROGRAMAS

Programa	Símbolos	Descrição
----------	----------	-----------

## Programas enérgicos e delicados

<b>1</b>		<b>Intensivo</b> Apto para lavar a loiça e tachos de uso diário muito sujos.
<b>2</b>		<b>Universal</b> Adequado para lavar a loiça e tachos de uso diário com sujidade normal. Programa segundo normas I.E.C. 436.
<b>3</b>	<b>ECO</b>	<b>Eco 55°C</b> Adequado para lavar a loiça e tachos de uso diário imediatamente após a refeição. Programa segundo normas EN 50242.
<b>4</b>		<b>Delicado</b> Adequado para lavar a loiça delicada e decorada, assim como os cristais. Indicado também para lavar a loiça de uso diário pouco suja, exceptuando as frigideiras.
<b>5</b>		<b>Secagem quente e aquecimento de pratos</b> Próprio para a secagem de loiças não utilizada há certo tempo e para aquecer loiças a utilizar para servir à mesa determinados pratos.

## Programas rápidos

<b>-</b>		<b>Pré-aquecimento</b> Fase de aquecimento da água que se efectua antes de colocar a loiça.
<b>6</b>	<b>R</b>	<b>Rápido 18 minutos</b> Ciclo super-rápido que se efectua no final da refeição depois do pré-aquecimento da água, indicado para cargas pequenas (4/6 pessoas).
<b>7</b>		<b>Pré-lavagem a frio</b> Pré-lavagem rápida para a loiça usada pela manhã ou pelo almoço, quando se quer realizar apenas uma lavagem depois do jantar.

	Operações a realizar					Desenvolvimento do programa					Duração média em minutos	Funções especiais		
	Detergente pré-lavagem	Detergente lavagem	Limpeza do filtro e placa	Controlo do nível de abrilhantador	Controlo do nível de sal	Pré-lavagem a quente	Pré-lavagem a frio	Lavagem	Enxaguamento intermédio	Enxaguamento a quente com abrilhantador		Com água fria (15°C)	Tecla Economia E	Tecla de meia carga

	●	●	●	●	●	○		65°C	○	○	105	SIM	SIM	
	●	●	●	●	●		○	65°C	○	○	100	SIM	SIM	
		●	●	●	●			55°C	○	○	80	SIM	SIM	
		●	●	●	●			55°C	○	○	70	SIM	SIM	SIM
			●	●				68°C	○	○	55		SIM	

											15		SIM	
		●	●					60°C	○		18		SIM	

			●				○				5		SIM	
--	--	--	---	--	--	--	---	--	--	--	---	--	-----	--





- IT
- FR
- DE
- ES
- EN
- PT

00.01 - 91500510 - Printed in Italy - Imprimé en Italie